



**ACCESSORI PER
ELETTROUTENSILI &
UTENSILI MANUALI
2026**









PUNTE PER EDILIZIA

Punte per edilizia - cilindriche e esagonali	4
Punte per muratura	4
Punte per gres, piastrelle e vetro	6
Punte per applicazioni speciali	7
Punte multimateriale	8
Punte per edilizia - sistema SDS Plus	12
Punte SDS Plus	12
Scalpellì SDS Plus	17
Punte per edilizia - sistema SDS Max	20
Scalpellì SDS Max	21
Punte per edilizia - sistema SDS Hex	22
Scalpellì SDS Hex	22



PUNTE PER METALLO

Punte per metallo	23
Punte a gradino e svasatori	26



PUNTE PER LEGNO

Punte per legno	33
Mecchie per legno	35
Punte per cerniere e fori ciechi	36
Svasatori	37



FRESE A TAZZA

Frese a tazza per legno e metallo	40
Frese a tazza diamantate	44
Carotatrici	47



BITS E ACCESSORI PER AVVITATURA

Bits double impact	49
Bits impact	50
Bits standard	52
Portabit	55
Chiavi a bussola e adattatori	58



CHIAVI A BUSSOLA PER AUTO

Chiavi a bussola per auto	66
---------------------------	----



SET PER FORARE E AVVITARE

Set per forare e avvitare	68
---------------------------	----



DISCHI E MOLE DIAMANTATE

Dischi diamantati	71
Dischi diamantati a corona continua	72
Dischi diamantati a corona continua scanalata	73
Dischi diamantati a corona segmentata	74
Dischi diamantati multimateriale	75
Dischi diamantati per tagliapietre e tagliapiastrelle	77
Mole diamantate	79



DISCHI ABRASIVI

Dischi abrasivi per metallo	82
Dischi abrasivi per pietra e mattoni	83
Dischi abrasivi multimateriale	83
Disco per troncatrice per metallo	85
Dischi lamellari abrasivi	86



LAME PER SEGNETTO ALTERNATIVO

Lame per legno	89
Lame per laminato	90
Lame per metallo	91
Lame multimateriale	91
Lame per applicazioni speciali	92



LAME PER GATTUCCIO

Lame multimateriale - ricondizionamento pallet	95
Lame per metallo	96
Lame per edilizia	97
Lame per legno	98
Lame per potatura e legno verde	99
Lame per applicazioni speciali	99



ACCESSORI PER UTENSILE MULTIFUNZIONE

Lame multimateriale	101
Lame per piastrelle e ceramica	102
Lame per metallo	103
Lame per legno	104
Altri accessori	105



LAME CIRCOLARI E A NASTRO

Lame per seghe circolari	108
Lame per macchine portatili	108
Lame per macchine stazionarie	111
Lame per mini sega	111
Lama per fresatrice orizzontale	112



ACCESSORI PER FALEGNAMERIA

Lame per pialla	113
Lame per traforo oscillante	114
Strumenti per falegnameria	115
Elementi di collegamento	115
Strumenti per fissaggio	116
Sgorbie e scalpelli per legno	118



CARTA ABRASIVA

Carta abrasiva per levigatrici da muro	119
Carta abrasiva per levigatrici orbitali rettangolari	121
Carta abrasiva per levigatrici orbitali triangolari	125
Carta abrasiva per levigatrici orbitali delta	126
Carta abrasiva per levigatrici rotorbitali	127
Carta abrasiva per levigatrici a nastro	128
Carta abrasiva per levigatrici combinate	130
Dischi in fibra per smerigliatrice	130
Levigatura manuale	131



ACCESSORI PER LUCIDATURA

Accessori per lucidatura	135
--------------------------	-----



SPAZZOLE

Spazzole in filo d'acciaio	139
Spazzole in filo d'ottone	142
Spazzole in filo di nylon	143
Spazzole manuali	143



FRESE, MOLE E RASPE ROTATIVE

Frese rotative	147
Mole rotative	152
Raspe rotative	154
Mole abrasive lamellari	156



FRUSTE PER MISCELATORI

Fruste per miscelatori	157
------------------------	-----



ATTREZZATURA PER ELETTROUTENSILI

Accessori per trapano	159
Mandrini	159
Platorelli	161
Altro	161
Accessori per smerigliatrice angolare	162
Ghiere di serraggio	162
Chiavi di serraggio	163
Platorelli	163
Supporti per elettrodomestici	164



UTENSILI MANUALI

Valigette	166
Giraviti	169
Chiavi di serraggio	172
Pinze e Tronchesi	175
Utensili per maschiatura e filettatura	178
Forbici e Cesioie	180
Rivettatrici e Occhiellatrici	181
Spatole	182
Ventose per sollevamento	182
Pistola per poliuretano	182
Coltelli e cutter	183
Strumenti di misurazione	185
Accessori da lavoro	187



PUNTE PER EDILIZIA

PUNTE CON ATTACCO CILINDRICO O ESAGONALE



PUNTE PER MURATURA

PUNTA CILINDRICA PER MURO ROCKER

PROFESSIONAL

- Spirale rinforzata
- Placca in metallo duro
- Foro molto preciso

Per cemento, granito, calcestruzzo, pietra naturale e mattoni



Art.	Ø	Lunghezza lavoro	Lunghezza totale	EAN	📦
49044630	3,0mm	40mm	70mm	4009310446302	10
49044640	4,0mm	40mm	75mm	4009310446402	10
49044650	5,0mm	50mm	85mm	4009310446502	10
49044660	6,0mm	60mm	100mm	4009310446602	10
49044670	7,0mm	70mm	110mm	4009310446702	10
49044680	8,0mm	80mm	120mm	4009310446801	10
49044700	10,0mm	80mm	120mm	4009310447002	10
49044720	12,0mm	90mm	138mm	4009310447204	5
49044740	14,0mm	90mm	150mm	4009310447402	5
49044760	16,0mm	90mm	150mm	4009310447600	5



PUNTA CILINDRICA PER MURO ROCKER - LUNGA

PROFESSIONAL

- Spirale rinforzata
- Placca in metallo duro
- Foro molto preciso

Per cemento, granito, calcestruzzo, pietra naturale e mattoni



Art.	Ø	Lunghezza lavoro	Lunghezza totale	EAN	📦
49045050	5,0mm	100mm	150mm	4009310450501	5
49045060	6,0mm	150mm	200mm	4009310450600	5
49045080	8,0mm	150mm	200mm	4009310450802	5
49045100	10,0mm	150mm	200mm	4009310451003	5
49045120	12,0mm	150mm	200mm	4009310451201	5



PUNTA CILINDRICA PER CEMENTO, PIETRA E MURO



EXPERT

- Foro pulito
- Qualità-prezzo
- Placca in metallo duro

*Per pietra naturale,
cemento e mattoni*



Art.	Ø	Lunghezza lavoro	Lunghezza totale	EAN	📦
49039630	3,0mm	40mm	70mm	4009310396304	10
49039640	4,0mm	40mm	75mm	4009310396403	10
49039650	5,0mm	50mm	85mm	4009310396502	10
49039660	6,0mm	60mm	100mm	4009310396601	10
49039670	7,0mm	65mm	105mm	4009310396700	10
49039680	8,0mm	80mm	120mm	4009310396809	10
49039700	10,0mm	80mm	120mm	4009310397001	10
49039720	12,0mm	90mm	138mm	4009310397202	5
49039740	14,0mm	90mm	138mm	4009310397400	5
49039750	16,0mm	90mm	138mm	4009310397509	5



PUNTA CILINDRICA PER CEMENTO, PIETRA E MURO - LUNGA



EXPERT

- Foro pulito
- Qualità-prezzo
- Placca in metallo duro

*Per pietra naturale,
cemento e mattoni*



Art.	Ø	Lunghezza lavoro	Lunghezza totale	EAN	📦
49041006	6,0 mm	120 mm	200 mm	4009310410062	5
49041008	8,0 mm	120 mm	200 mm	4009310410082	5
49041010	10,0 mm	120 mm	200 mm	4009310410109	5
49041012	12,0 mm	120 mm	200 mm	4009310410123	5
49041014	14,0 mm	120 mm	200 mm	4009310410147	5
49041016	16,0 mm	120 mm	200 mm	4009310410161	5
49041806	6,0 mm	200 mm	400 mm	4009310418063	5
49041808	8,0 mm	200 mm	400 mm	4009310418089	5
49041810	10,0 mm	200 mm	400 mm	4009310418101	5
49041812	12,0 mm	200 mm	400 mm	4009310418123	5
49041814	14,0 mm	200 mm	400 mm	4009310418143	5
49041816	16,0 mm	200 mm	400 mm	4009310418167	5
49041818	18,0 mm	200 mm	400 mm	4009310418181	5
49041820	20,0 mm	200 mm	400 mm	4009310418204	5



PUNTA CILINDRICA PER MURO



EXPERT

- Qualità-prezzo
- Placca in metallo duro

*Per muro
e mattoni*



Art.	Ø	Lunghezza lavoro	Lunghezza totale	EAN	📦
49037030	3,0mm	40mm	70mm	4009310370304	10
49037040	4,0mm	40mm	75mm	4009310370403	10
49037050	5,0mm	50mm	85mm	4009310370502	10
49037060	6,0mm	60mm	100mm	4009310370601	10
49037080	8,0mm	80mm	120mm	4009310370809	10
49037090	9,0mm	80mm	120mm	4009310370908	10
49037100	10,0mm	80mm	120mm	4009310371004	10
49037120	12,0mm	90mm	138mm	4009310371202	5
49037130	13,0mm	90mm	138mm	4009310371301	5
49037140	14,0mm	90mm	138mm	4009310371400	5
49037160	16,0mm	90mm	138mm	4009310371608	5



PUNTE PER GRES, PIASTRELLE E VETRO

PUNTA CONICA PER GRES PORCELLANATO A CODOLO ESAGONALE



PROFESSIONAL

- Punta conica
- Angolo asimmetrico

*Per gres, ceramica e marmo
Ottimale con foratura ad acqua*



Art.	Ø	Lunghezza lavoro	Lunghezza totale	EAN	Imb.
49051604	4,0mm	40mm	80mm	4009310516049	10
49051605	5,0mm	45mm	90mm	4009310516052	10
49051606	6,0mm	45mm	90mm	4009310516061	10
49051608	8,0mm	45mm	90mm	4009310516083	10
49051610	10,0mm	45mm	90mm	4009310516105	10
49051612	12,0mm	55mm	110mm	4009310516122	5



PUNTA CILINDRICA A FRECCIA PER VETRO



CLASSIC

- Placchetta in metallo duro
 - Ingresso facilitato
- Per vetro e ceramiche morbide*



Art.	Ø	Lunghezza totale	EAN	📦
49177203	3,0mm	58mm		10
49177204	4,0mm	64mm		10
49177205	5,0mm	70mm		10
49177206	6,0mm	75mm		10
49177208	8,0mm	83mm		10
49177210	10,0mm	90mm		10
49177212	12,0mm	97mm		10



SET DI PUNTE A FRECCIA PER VETRO - 5PZ.



CLASSIC

- Placchetta in metallo duro
 - Ingresso facilitato
- Per vetro e ceramiche morbide*

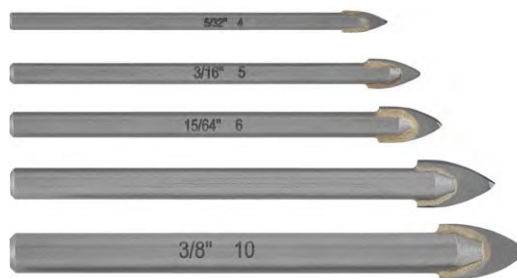

Art.	N° pezzi	Ø	EAN	📦
49177200	5	4, 5, 6, 8, 10mm		6



PUNTE PER APPLICAZIONI SPECIALI

PUNTA CILINDRICA PER MATERIALI DURI - HARD CUT



PROFESSIONAL

- Placca in metallo duro
 - Angolo 120° asimmetrico
 - Foratura ad acqua
- Per marmi, graniti, pietra naturale e ceramiche*



Art.	Ø	Lunghezza lavoro	Lunghezza totale	EAN	📦
49052630	3,0mm	40mm	70mm		5
49052640	4,0mm	40mm	75mm		5
49052650	5,0mm	50mm	85mm		5
49052660	6,0mm	60mm	100mm		5
49052680	8,0mm	75mm	120mm		5
49052700	10,0mm	75mm	120mm		5
49052720	12,0mm	90mm	150mm		5



PUNTE MULTIMATERIALE

PUNTA CILINDRICA MULTIMATERIALE EASY CUT



PROFESSIONAL

- Placca in metallo duro

*Per tutti i tipi di materiale
Per foratura attraverso più materiali*



Art.	Ø	Lunghezza lavoro	Lunghezza totale	EAN	📦
49048630	3,0mm	40mm	70mm	4009310486302	5
49048640	4,0mm	40mm	75mm	4009310486401	5
49048650	5,0mm	50mm	85mm	4009310486500	5
49048660	6,0mm	60mm	100mm	4009310486608	5
49048670	7,0mm	70mm	110mm	4009310486707	5
49048680	8,0mm	80mm	120mm	4009310486807	5
49048700	10,0mm	80mm	120mm	4009310487002	5
49048720	12,0mm	90mm	150mm	4009310487200	5

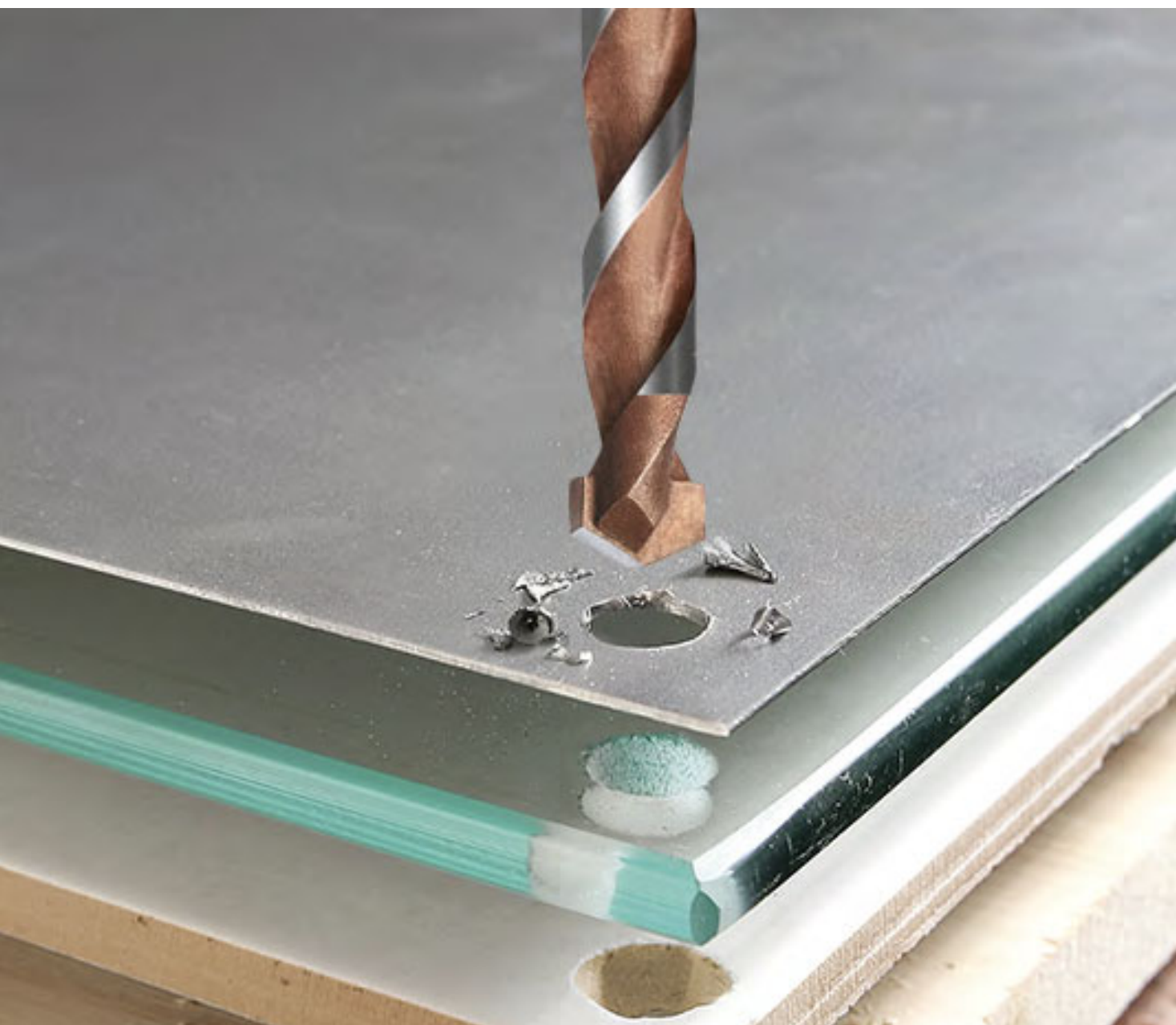

SET

EINHELL SET DI PUNTE A CODOLO ESAGONALE CONICHE PER GRES PORCELLANATO - 4PZ.



PROFESSIONAL

- Punta conica
- Angolo d'ingresso asimmetrico

*Per gres porcellanato, ceramica e marmo
Ottimale con foratura ad acqua*



Art.	N° pezzi	Ø	EAN	📦
49051404	4	5, 6, 8, 10mm		1

EINHELL SET DI PUNTE A CODOLO ESAGONALE PER GRES PORCELLANATO E PER MURO - 10PZ.



PROFESSIONAL

- Punta conica
- Angolo asimmetrico

*Per gres porcellanato,
ceramica e marmo,
cemento e calcestruzzo*

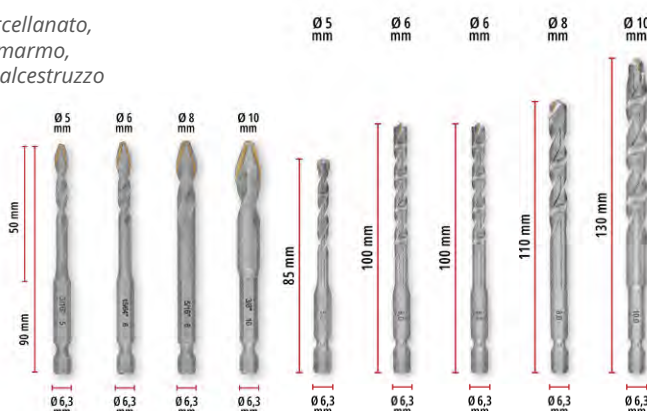

Art.	N° pezzi	Ø	EAN	📦
49051410	10	5, 6, 8, 10mm		1



**Soluzione all-in-one per forare pareti,
pavimenti o raccordi piastrellati**

EINHELL SET DI PUNTE PER EDILIZIA CON CODOLO ESAGONALE - 10PZ



EXPERT

- Set completo
- Rapporto qualità-prezzo
- Codolo esagonale

*Per cemento, calcestruzzo e mattoni
Punta in metallo duro*



Art.	N° pezzi	Ø	EAN	
49108743	10	3, 4, 5, 6, 7, 8, 9, 10 mm		1

SET DI PUNTE CILINDRICHE PER MURO ROCKER - 4PZ.



EXPERT

- Spirale rinforzata
- Placca in metallo duro
- Foro molto preciso

Per cemento, granito, calcestruzzo, pietra naturale e mattoni



Art.	N° pezzi	Ø	EAN	
49044800	4	5, 6, 8, 10 mm		6

SET DI PUNTE CILINDRICHE PER CEMENTO, PIETRA E MURO



CLASSIC

- Set completo
- Rapporto qualità-prezzo
- Scatoletta espositiva a ventaglio

Per cemento, pietra naturale, mattoni, calcestruzzo cavo



Art.	N° pezzi	Ø	EAN	
49109140	5	4, 5, 6, 8, 10 mm		8
49109145	8	3, 4, 5, 6, 7, 8, 9, 10 mm		8

SET PUNTE CILINDRICHE PER MATERIALI DURI HARD CUT - 4PZ.



PROFESSIONAL

- Placca in metallo duro
- Angolo 120° asimmetrico
- Foratura ad acqua

Per marmi, graniti, pietra naturale e ceramiche



Art.	N° pezzi	Ø	EAN	
49052800	4	5, 6, 8, 10mm		1

SET PUNTE ESAGONALI MULTIMATERIALE EASY-CUT - 5PZ.

PROFESSIONAL

- Placca in metallo duro

*Per tutti i tipi di materiale
Per foratura attraverso più materiali*



Art.	Ø	N° pezzi	EAN	
49048400	3, 4, 5, 6, 8 mm	5		6



PUNTE PER EDILIZIA

SISTEMA SDS PLUS



PUNTE SDS PLUS

PUNTA SDS PLUS 4 TAGLIANTI PER CEMENTO ARMATO



EXPERT

- Spirale singola
- Saldate alta temperatura
- Ottimo rendimento
- Testa in metallo duro

Per cemento, cemento armato, mattoni, blocchi e pietra naturale



Art.	Ø	Lunghezza lavoro	Lunghezza totale	EAN	📦
49260005	5,0mm	50mm	110mm	4009312600058	5
49260006	6,0mm	50mm	110mm	4009312600063	5
49260007	7,0mm	50mm	110mm	4009312600072	5
49260008	8,0mm	50mm	110mm	4009312600087	5
49260009	9,0mm	50mm	110mm	4009312600096	5
49260010	10,0mm	50mm	110mm	4009312600102	5
49260105	5,0mm	100mm	160mm	4009312601053	5
49260106	6,0mm	100mm	160mm	4009312601062	5
49260165	6,5mm	100mm	160mm	4009312601659	5
49260107	7,0mm	100mm	160mm	4009312601079	5
49260108	8,0mm	100mm	160mm	4009312601086	5
49260109	9,0mm	100mm	160mm	4009312601093	5
49260110	10,0mm	100mm	160mm	4009312601109	5
49260112	12,0mm	100mm	160mm	4009312601123	5
49260114	14,0mm	100mm	160mm	4009312601149	5
49260206	6,0mm	150mm	210mm	4009312602069	5
49260208	8,0mm	150mm	210mm	4009312602083	5
49260209	9,0mm	150mm	210mm	4009312602090	5
49260210	10,0mm	150mm	210mm	4009312602106	5
49260212	12,0mm	150mm	210mm	4009312602120	5
49260214	14,0mm	150mm	210mm	4009312602144	5
49260216	16,0mm	150mm	210mm	4009312602168	5





Art.	Ø	Lunghezza lavoro	Lunghezza totale	EAN	📦
49260306	6,0mm	200mm	260mm	4009312603066	5
49260365	6,5mm	200mm	260mm	4009312603653	5
49260308	8,0mm	200mm	260mm	4009312603080	5
49260310	10,0mm	200mm	260mm	4009312603103	5
49260312	12,0mm	200mm	260mm	4009312603127	5
49260314	14,0mm	200mm	260mm	4009312603141	5
49260408	8,0mm	400mm	460mm	4009312604087	1
49260410	10,0mm	400mm	460mm	4009312604100	1
49260412	12,0mm	400mm	460mm	4009312604124	1
49260414	14,0mm	400mm	460mm	4009312604148	1
49260416	16,0mm	400mm	460mm	4009312604162	1
49260418	18,0mm	400mm	460mm	4009312604186	1
49260420	20,0mm	400mm	460mm	4009312604209	1
49260422	22,0mm	400mm	460mm	4009312604223	1
49260425	25,0mm	400mm	460mm	4009312604254	1
49260428	28,0mm	400mm	460mm	4009312604285	1
49260430	30,0mm	400mm	460mm	4009312604308	1



La doppia spirale fresata garantisce un'efficace rimozione della polvere di foratura



40Cr

Corpo in acciaio 40Cr per una lunga durata e un avanzamento efficiente

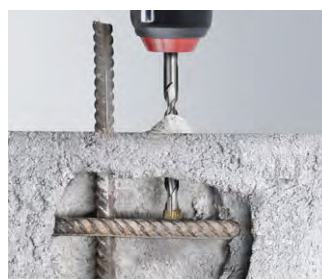

La speciale geometria della piastra impedisce l'inzeppamento nel cemento armato



HM TC

Inserto in carburo a quattro tagli, resistente agli urti, per prestazioni elevate

PUNTA SDS PLUS 2 TAGLIENTI PER EDILIZIA

EXPERT

- Spirale singola
- Saldate alta temperatura
- Testa in metallo duro
- Maggiore velocità
- Certificato PGM

Per cemento, cemento armato, calcestruzzo, mattoni e pietra naturale



Art.	Ø	Lunghezza lavoro	Lunghezza totale	EAN	📦
49241134	4,0mm	50mm	110mm	4009312411340	5
49241135	5,0mm	50mm	110mm	4009312411357	5
49241136	6,0mm	50mm	110mm	4009312411364	5
49241138	8,0mm	50mm	110mm	4009312411388	5
49241139	9,0mm	50mm	110mm	4009312411395	5
49241140	10,0mm	50mm	110mm	4009312411401	5
49241635	5,0mm	100mm	160mm	4009312416352	5
49241636	6,0mm	100mm	160mm	4009312416369	5
49241637	7,0mm	100mm	160mm	4009312416372	5
49241638	8,0mm	100mm	160mm	4009312416383	5
49241639	9,0mm	100mm	160mm	4009312416390	5
49241640	10,0mm	100mm	160mm	4009312416402	5
49241642	12,0mm	100mm	160mm	4009312416420	5
49241644	14,0mm	100mm	160mm	4009312416444	5





Art.	Ø	Lunghezza lavoro	Lunghezza totale	EAN	📦
49242136	6,0mm	150mm	210mm	4009312421363	5
49242138	8,0mm	150mm	210mm	4009312421387	5
49242139	9,0mm	150mm	210mm	4009312421394	5
49242140	10,0mm	150mm	210mm	4009312421400	5
49242142	12,0mm	150mm	210mm	4009312421424	5
49242144	14,0mm	150mm	210mm	4009312421448	5
49242146	16,0mm	150mm	210mm	4009312421462	5
49242148	18,0mm	150mm	210mm	4009312421486	5
49242150	20,0mm	150mm	210mm	4009312421509	5
49242636	6,0mm	200mm	260mm	4009312426368	5
49242638	8,0mm	200mm	260mm	4009312426382	5
49242640	10,0mm	200mm	260mm	4009312426405	5
49242642	12,0mm	200mm	260mm	4009312426429	5
49242644	14,0mm	200mm	260mm	4009312426453	5
49242645	15,0mm	200mm	260mm	4009312426470	5
49243138	8,0mm	250mm	310mm	4009312431386	5
49243140	10,0mm	250mm	310mm	4009312431409	5
49243144	14,0mm	250mm	310mm	4009312431427	5
49243146	16,0mm	250mm	310mm	4009312431441	5
49243148	18,0mm	250mm	310mm	4009312431465	1
49243150	20,0mm	250mm	310mm	4009312431508	1
49244638	8,0mm	400mm	460mm	4009312446380	1
49244640	10,0mm	400mm	460mm	4009312446403	1
49244642	12,0mm	400mm	460mm	4009312446427	1
49244644	14,0mm	400mm	460mm	4009312446441	1
49244646	16,0mm	400mm	460mm	4009312446465	1
49244648	18,0mm	400mm	460mm	4009312446489	1
49244650	20,0mm	400mm	460mm	4009312446502	1
49244652	22,0mm	400mm	460mm	4009312446526	1
49244654	24,0mm	400mm	460mm	4009312446540	1
49244655	25,0mm	400mm	460mm	4009312446557	1
49244658	28,0mm	400mm	460mm	4009312446588	1
49244660	30,0mm	400mm	460mm	4009312446601	1



PUNTA SDS PLUS 2 TAGLIANTI MULTIMATERIALE EASY-CUT

PROFESSIONAL

- Spirale multipla MS 5
- Tungsteno-Titanio-HM
- Certificato PGM

*Per cemento, legno, lamiera
granito, marmo, vetro e plastica*



Art.	Ø	Lunghezza lavoro	Lunghezza totale	EAN	📦
49266104	4,0mm	50mm	110mm	4009312661041	5
49266105	5,0mm	50mm	110mm	4009312661059	5
49266606	6,0mm	100mm	160mm	4009312666061	5
49266608	8,0mm	100mm	160mm	4009312666085	5
49266610	10,0mm	100mm	160mm	4009312666108	5
49266612	12,0mm	100mm	160mm	4009312666122	5



PUNTE SDS PLUS 2 TAGLIANTI PER EDILIZIA



EXPERT

- Saldate alta temperatura
- Ottimo rapporto
- Qualità-prezzo

Per cemento, mattoni e pietra naturale



Art.	Ø	Lunghezza lavoro	Lunghezza totale	EAN	📦
49265004	4,0mm	50mm	110mm	4009312650042	5
49265005	5,0mm	50mm	110mm	4009312650053	5
49265006	6,0mm	50mm	110mm	4009312650060	5
49265008	8,0mm	50mm	110mm	4009312650084	5
49265009	9,0mm	50mm	110mm	4009312650091	5
49265010	10,0mm	50mm	110mm	4009312650107	5
49265105	5,0mm	100mm	160mm	4009312651050	5
49265106	6,0mm	100mm	160mm	4009312651067	5
49265108	8,0mm	100mm	160mm	4009312651081	5
49265109	9,0mm	100mm	160mm	4009312651098	5
49265110	10,0mm	100mm	160mm	4009312651104	5
49265112	12,0mm	100mm	160mm	4009312651128	5
49265206	6,0mm	150mm	210mm	4009312652064	5
49265208	8,0mm	150mm	210mm	4009312652088	5
49265209	9,0mm	150mm	210mm	4009312652095	5
49265210	10,0mm	150mm	210mm	4009312652101	5
49265212	12,0mm	150mm	210mm	4009312652125	5
49265214	14,0mm	150mm	210mm	4009312652149	5
49265216	16,0mm	150mm	210mm	4009312652163	5
49265306	6,0mm	200mm	260mm	4009312653061	5
49265365	6,5mm	200mm	260mm	4009312653658	5
49265308	8,0mm	200mm	260mm	4009312653085	5
49265310	10,0mm	200mm	260mm	4009312653108	5
49265312	12,0mm	200mm	260mm	4009312653122	5
49265314	14,0mm	200mm	260mm	4009312653146	5
49265408	8,0mm	400mm	460mm	4009312654082	1
49265410	10,0mm	400mm	460mm	4009312654105	1
49265412	12,0mm	400mm	460mm	4009312654129	1
49265414	14,0mm	400mm	460mm	4009312654143	1
49265416	16,0mm	400mm	460mm	4009312654167	1
49265418	18,0mm	400mm	460mm	4009312654181	1
49265420	20,0mm	400mm	460mm	4009312654204	1
49265422	22,0mm	400mm	460mm	4009312654228	1
49265425	25,0mm	400mm	460mm	4009312654252	1
49265428	28,0mm	400mm	460mm	4009312654280	1



CORONE PER CAROTAGGIO

CORONA IN METALLO DURO PER CALCESTRUZZO CON CODOLO SDS PLUS



PROFESSIONAL

- Punta centraggio 8 mm
- Placche di metallo duro termoresistenti
- Saldatura robusta



Art.	Ø	Codolo	EAN	📦
49175339	35mm	SDS Plus	4009311753397	1
49175340	40mm	SDS Plus	4009311753403	1
49175366	68mm	SDS Plus	4009311753663	1
49175380	82mm	SDS Plus	4009311753809	1



SET

EINHELL SET PUNTA SDS PLUS 4 TAGLIANTI PER CEMENTO ARMATO 160 MM - 7PZ.



EXPERT

- Spirale singola
- Saldate alta temperatura
- Buon rendimento
- Testa in metallo duro

*Per cemento, cemento armato,
mattoni, blocchi e pietra naturale*

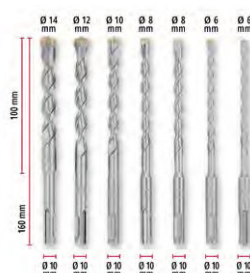

Art.	N°pezzi	Lunghezza totale	Ø	EAN	📦
49265510	7	160mm	6-8-10-12-14mm	4009312695102	1

EINHELL SET PUNTA SDS PLUS 4 TAGLIANTI PER CEMENTO ARMATO 210 MM - 7PZ.



EXPERT

- Spirale singola
- Saldate alta temperatura
- Buon rendimento
- Testa in metallo duro

*Per cemento, cemento armato,
mattoni, blocchi e pietra naturale*

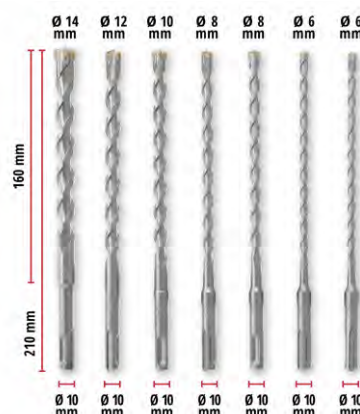

Art.	N°pezzi	Lunghezza totale	Ø	EAN	📦
49265515	7	210mm	6-8-10-12-14mm	4009312695152	1



SCALPELLI SDS PLUS

SCALPELLI SDS PLUS IN ACCIAIO CR-MO



EXPERT

- Acciaio Cr-Mo di alta qualità
- Vita utensile prolungata



Art.	Larghezza punta	Lunghezza totale	EAN	
49247210	14,0mm	250mm		1



Art.	Larghezza punta	Lunghezza totale	EAN	
49247302	20,0mm	250mm		1



Art.	Larghezza punta	Lunghezza totale	EAN	
49247304	40,0mm	250mm		1



Art.	Larghezza punta	Lunghezza totale	EAN	
49247410	25,0mm	250mm		1



Art.	Larghezza punta	Lunghezza totale	EAN	
49247504	40,0mm	250mm		1



SCALPELLI SDS PLUS 250MM



CLASSIC

- Ottimo rapporto qualità-prezzo



Art.	Larghezza punta	Lunghezza totale	EAN	
49247191	14,0mm	250mm		1



Art.	Larghezza punta	Lunghezza totale	EAN	
49247192	20,0mm	250mm		1



Art.	Larghezza punta	Lunghezza totale	EAN	
49247193	40,0mm	250mm		1



SET

SET SCALPELLI SDS PLUS CORTI - 3PZ.

CLASSIC

- Riduzione delle rotture
- Facile e pronto all'uso



Art.	N°pezzi	Larghezza punta	Lunghezza totale	EAN	
49247185	3	14, 20, 40mm	140mm	4009312471858	5

EINHELL SET SCALPELLI SDS PLUS 250 MM - 3PZ.

EXPERT

- Set completo
- Uso intensivo
- Impieghi pesanti
- Pratico tubo in plastica trasparente

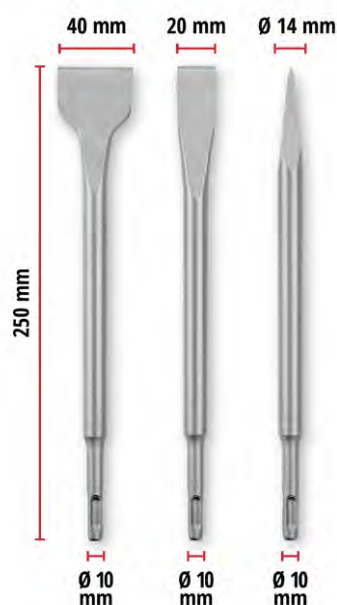

Art.	N°pezzi	Larghezza punta	Lunghezza totale	EAN	
49247200	3	14, 20, 40mm	250mm	4009312472008	3

EINHELL SET SCALPELLI SDS PLUS 250 MM - 4PZ.

EXPERT

- Set completo
- Uso intensivo
- Impieghi pesanti
- Pratico tubo in plastica trasparente



Art.	N°pezzi	Larghezza punta	Lunghezza totale	EAN	
49247205	4	14, 20, 30, 40mm	250mm	4009312472051	2

SET DI PUNTE E SCALPELLI SDS PLUS - 12PZ.



CLASSIC

Scalpello piatto e a punta 250mm
 Punta SDS Plus Ø 5-6x110mm
 Punta SDS Plus Ø 8-10-12x160mm
 Punta SDS Plus Ø 8-10x210mm
 Punta SDS Plus Ø 12-14-16x260mm



Art.	N°pezzi	Ø	Lunghezza totale	EAN	
49240295	12	5,6,8,10,12,14,16mm	110, 160, 210, 260mm		1

SET MISTO DI PUNTE E SCALPELLI SDS PLUS - 6PZ.



CLASSIC



Art.	N°pezzi	Ø	Lunghezza totale	EAN	
49109166	6	5, 6, 8, 10mm	110, 160, 260mm		1

PUNTE PER EDILIZIA

SISTEMA SDS MAX



PUNTE SDS MAX

PUNTA SDS MAX 4 TAGLIENTI



EXPERT

- Spirale singola
- Saldate alta temperatura
- Ottimo rendimento
- Testa in metallo duro

Per cemento, calcestruzzo armato, granito, mattoni e pietra naturale



Art.	Ø	Lunghezza lavoro	Lunghezza totale	EAN	📦
49195516	16,0mm	480mm	540mm		1
49195518	18,0mm	480mm	540mm		1
49195520	20,0mm	480mm	540mm		1
49195522	22,0mm	480mm	540mm		1
49195525	25,0mm	480mm	540mm		1
49195528	28,0mm	510mm	570mm		1
49195530	30,0mm	510mm	570mm		1
49195532	32,0mm	510mm	570mm		1
49195535	35,0mm	510mm	570mm		1
49195540	40,0mm	510mm	570mm		1



SCALPELLI SDS MAX

SCALPELLO SDS MAX A PUNTA



Art.	Larghezza punta	Lunghezza totale	EAN	
49190141	18,0mm	400mm		1

SCALPELLO SDS MAX PIATTO 400MM



Art.	Larghezza punta	Lunghezza totale	EAN	
49190240	20mm	400mm		1

SCALPELLO SDS MAX PIATTO 350MM



Art.	Larghezza punta	Lunghezza totale	EAN	
49190340	50,0mm	350mm		1

SCALPELLO SDS MAX PIATTO 300MM



Art.	Larghezza punta	Lunghezza totale	EAN	
49190430	80,0mm	300mm		1

SCALPELLO SDS MAX 400MM

CLASSIC

- Ottimo rapporto qualità-prezzo



Art.	Larghezza punta	Lunghezza totale	EAN	
49194010	18,0mm	400mm		5



Art.	Larghezza punta	Lunghezza totale	EAN	
49194020	25mm	400mm		5



Art.	Larghezza punta	Lunghezza totale	EAN	
49194030	50mm	400mm		5



Art.	Larghezza punta	Lunghezza totale	EAN	
49194040	50mm	400mm		5



SET

EINHELL SET DI SCALPELLI SDS MAX - 3PZ.

EXPERT

- Set completo
- Uso intensivo
- Impieghi pesanti
- Pratico tubo in plastica trasparente

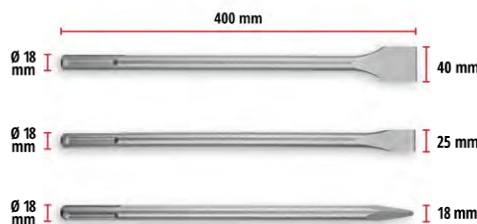

Art.	N°pezzi	Larghezza punta	Lunghezza totale	EAN	
49190110	3	18, 25, 40mm	400mm		2



SET MISTO DI PUNTE E SCALPELLI SDS MAX - 5PZ.



CLASSIC

- Ottimo rapporto qualità-prezzo
- Assortimento completo

Scalpello piatto e a punta
Punte SDS Max ø 18-20-25x400 mm



Art.	N°pezzi	Ø	Lunghezza totale	EAN	📦
49194005	5	18, 20, 25mm	400mm		1



PUNTE PER EDILIZIA

SISTEMA SDS HEX



SCALPELLI CON CODOLO ESAGONALE SDS HEX

EXPERT

- Per martelli pesanti
- Robusto e solido



Art.	Larghezza punta	Lunghezza totale	EAN	📦
49191045	30,0mm	410mm		1
49191145	18,0mm	410mm		1

PUNTE PER METALLO



PUNTE PER METALLO

PUNTE AL COBALTO HSS-G PER INOX E METALLO - BLISTER

PROFESSIONAL

- Angolo di taglio 135°
- 5% Cobalto
- Autocentrante
- DIN 338

Per acciaio inox, metalli, ghisa, rame, zinco, bronzo e plastica



Art.	Ø	Lunghezza lavoro	Lunghezza totale	EAN	📦
49248610	1,0mm	12mm	34mm	4009312486102	10
49248615	1,5mm	18mm	43mm	4009312486157	10
49248620	2,0mm	24mm	49mm	4009312486201	10
49248625	2,5mm	30mm	57mm	4009312486252	10
49248630	3,0mm	33mm	61mm	4009312486300	10
49248633	3,3mm	37mm	70mm	4009312486331	10
49248635	3,5mm	37mm	70mm	4009312486351	10
49248640	4,0mm	40mm	75mm	4009312486409	5
49248642	4,2mm	45mm	80mm	4009312486423	5
49248645	4,5mm	45mm	80mm	4009312486452	5
49248650	5,0mm	51mm	86mm	4009312486508	5
49248655	5,5mm	54mm	93mm	4009312486553	5
49248660	6,0mm	57mm	93mm	4009312486607	5
49248665	6,5mm	61mm	101mm	4009312486652	5
49248668	6,8mm	65mm	105mm	4009312486683	5
49248670	7,0mm	67mm	109mm	4009312486702	3
49248675	7,5mm	69mm	109mm	4009312486751	3
49248680	8,0mm	73mm	117mm	4009312486805	3
49248685	8,5mm	75mm	117mm	4009312486850	3
49248690	9,0mm	79mm	125mm	4009312486900	3
49248695	9,5mm	81mm	125mm	4009312486959	3
49248700	10,0mm	86mm	133mm	4009312487000	3
49248710	11,0mm	94mm	145mm	4009312487109	2
49248720	12,0mm	101mm	156mm	4009312487208	2
49248730	13,0mm	101mm	162mm	4009312487307	2



PUNTE AL COBALTO HSS-G PER INOX E METALLO - SFUSE

PROFESSIONAL

- Angolo di taglio 135°
- 5% Cobalto
- Autocentrante

*Per acciaio inox,
metalli, ghisa,
rame, zinco,
bronzo e plastica*

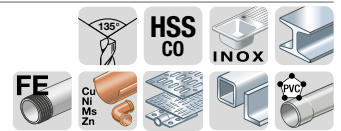

Art.	Ø	Lunghezza lavoro	Lunghezza totale	EAN	📦
49248010	1,0mm	12mm	34mm	4009312480100	10
49248015	1,5mm	18mm	43mm	4009312480153	10
49248020	2,0mm	24mm	49mm	4009312480209	10
49248025	2,5mm	30mm	57mm	4009312480254	10
49248030	3,0mm	33mm	61mm	4009312480308	10
49248033	3,3mm	36mm	70mm	4009312480339	10
49248035	3,5mm	39mm	70mm	4009312480351	10
49248040	4,0mm	43mm	75mm	4009312480407	5
49248042	4,2mm	43mm	80mm	4009312480421	5
49248045	4,5mm	47mm	80mm	4009312480452	5
49248050	5,0mm	52mm	86mm	4009312480506	5
49248055	5,5mm	57mm	93mm	4009312480551	5
49248060	6,0mm	57mm	93mm	4009312480605	5
49248065	6,5mm	63mm	101mm	4009312480650	5
49248068	6,8mm	63mm	103mm	4009312480681	5
49248070	7,0mm	69mm	109mm	4009312480704	3
49248075	7,5mm	69mm	109mm	4009312480759	3
49248080	8,0mm	75mm	117mm	4009312480805	3
49248085	8,5mm	75mm	117mm	4009312480858	3
49248090	9,0mm	81mm	125mm	4009312480903	3
49248095	9,5mm	81mm	125mm	4009312480957	3
49248100	10,0mm	87mm	133mm	4009312481008	3

PUNTA SILVER STAR HSS-G PER METALLO

EXPERT

- Angolo di taglio 135°
- Finitura trasversale
- Rettifica di precisione

*Per metallo,
ghisa e ferro*

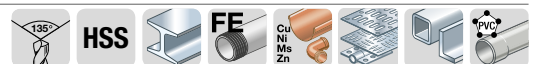

Art.	Ø	Lunghezza lavoro	Lunhezza. totale	EAN	📦
49206510	1,0mm (2pz.)	12mm	34mm	4009312065109	10
49206515	1,5mm (2pz.)	18mm	43mm	4009312065154	10
49206520	2,0mm (2pz.)	24mm	49mm	4009312065208	10
49206525	2,5mm (2pz.)	30mm	57mm	4009312065253	10
49206530	3,0mm (2pz.)	33mm	61mm	4009312065307	10
49206532	3,2mm	36mm	70mm	4009312065321	10
49206533	3,3mm	36mm	70mm	4009312065338	10
49206535	3,5mm	39mm	70mm	4009312065352	10
49206540	4,0mm	43mm	75mm	4009312065406	10
49206542	4,2mm	43mm	80mm	4009312065420	10
49206545	4,5mm	47mm	80mm	4009312065451	10
49206550	5,0mm	52mm	86mm	4009312065505	10
49206555	5,5mm	57mm	93mm	4009312065550	10
49206560	6,0mm	57mm	93mm	4009312065604	10
49206565	6,5mm	63mm	101mm	4009312065659	10
49206568	6,8mm	63mm	103mm	4009312065680	10





Art.	Ø	Lunghezza lavoro	Lunhezza. totale	EAN	📦
49206570	7,0mm	69mm	109mm		10
49206575	7,5mm	69mm	109mm		10
49206580	8,0mm	75mm	117mm		10
49206585	8,5mm	75mm	117mm		10
49206590	9,0mm	81mm	125mm		10
49206600	10,0mm	87mm	133mm		10
49206602	10,2mm	87mm	133mm		5
49206610	11,0mm	94mm	145mm		5
49206620	12,0mm	101mm	156mm		5
49206630	13,0mm	101mm	162mm		5

PUNTA HSS-R PER METALLO



CLASSIC

- Angolo di taglio 118°
- Laminatura a rullo
- Rettifica di precisione

*Per metallo, lamiera, bronzo
alluminio, plastica e PVC*



Art.	Ø	Lunghezza lavoro	Lunghezza totale	EAN	📦
49209610	1,0mm	12mm	34mm		10
49209615	1,5mm	18mm	43mm		10
49209620	2,0mm	24mm	49mm		10
49209625	2,5mm	30mm	57mm		10
49209630	3,0mm	33mm	61mm		10
49209635	3,5mm	39mm	70mm		10
49209640	4,0mm	43mm	75mm		10
49209645	4,5mm	47mm	80mm		10
49209648	4,8mm	52mm	86mm		10
49209650	5,0mm	52mm	86mm		10
49209655	5,5mm	57mm	93mm		10
49209660	6,0mm	57mm	93mm		10
49209665	6,5mm	63mm	101mm		10
49209670	7,0mm	69mm	109mm		10
49209680	8,0mm	75mm	117mm		10
49209685	8,5mm	75mm	117mm		10
49209690	9,0mm	81mm	125mm		10
49209700	10,0mm	87mm	133mm		10
49209705	10,5mm	87mm	133mm		5
49209710	11,0mm	94mm	145mm		5
49209720	12,0mm	101mm	156mm		5
49209730	13,0mm	101mm	162mm		5



PUNTA HSS-R PER METALLO A CODOLO RIDOTTO



CLASSIC

- Angolo di taglio 118°
- Laminatura a rullo
- Rettifica di precisione

*Per metallo, lamiera, bronzo
alluminio, plastica e PVC*



Art.	Ø	Lunhezza lavoro	Lunhezza totale	EAN	📦
49159130	13,0mm	90mm	162mm	4009311591302	5
49159140	14,0mm	108mm	173mm	4009311591401	5
49159150	15,0mm	108mm	173mm	4009311591500	5
49159160	16,0mm	120mm	180mm	4009311591609	5
49159170	17,0mm	125mm	180mm	4009311591708	5
49159180	18,0mm	130mm	180mm	4009311591807	5
49159190	19,0mm	130mm	180mm	4009311591906	5
49159200	20,0mm	130mm	180mm	4009311592002	5



PUNTE PER METALLO HSS-G ATTACCO ESAGONALE



CLASSIC

- Angolo di taglio 135°
- Finitura trasversale
- Rettifica di precisione

*Per metallo,
ghisa e ferro*



Art.	Ø	Lunhezza lavoro	Lunhezza totale	EAN	📦
49421102	2.0mm	30mm	60mm	4009314211023	10
49421125	2.5mm	30mm	60mm	4009314211252	10
49421103	3.0mm	30mm	60mm	4009314211030	10
49421135	3.5mm	30mm	60mm	4009314211351	10
49421104	4.0mm	30mm	60mm	4009314211049	10
49421105	5.0mm	30mm	60mm	4009314211054	10
49421106	6.0mm	30mm	60mm	4009314211061	10



PUNTE A GRADINO E SVASATORI

PUNTA A GRADINO HSS PER METALLO



PROFESSIONAL

- Per arrotondare i bordi
- Taglio senza sbavi
- Senza perforatura

*Per lamiere
metalliche
materiali non
ferrosi e plastica*



Art.	Ø codolo	Ø minimo	Ø massimo	EAN	📦
49525820	8mm	49525820	4 - 20mm	4009315258201	1
49525830	10mm	49525830	6 - 30mm	4009315258300	1

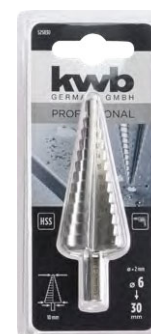



SET DI PUNTE A GRADINO E LIMA

CLASSIC

- Coating in Titanio
- Taglio senza bave
- Senza pre-foro

Per lamiera in metallo e acciaio inox
Diametro per maschiatura: 6mm



Art.	N°pezzi	Ø minimo	Ø massimo	EAN	
49525890	3	4mm	12-30mm	4009345258904	1

SVASATORE PER METALLO HSS 5 TAGLIENTI

PROFESSIONAL

- Taglio senza sbavi

Per lamiere metalliche materiali non ferrosi e plastica

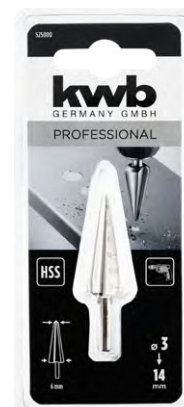

Art.	Ø codolo	Ø minimo	Ø massimo	EAN	
49525000	6mm	3mm	14mm	4009345250007	1
49525100	8mm	5mm	20mm	4009345251004	1
49525200	10mm	16mm	30mm	4009345252001	1

SVASATORE PER METALLO HSS 5 TAGLIANTI

PROFESSIONAL

Per ferro, lamiere e materiali non ferrosi

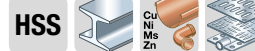

Art.	Ø codolo	Ø	EAN	📦
49704340	8 mm	12 mm	4009317023209	6
49704440	8 mm	16 mm	4009317024208	6

SET DI ESTRATTORI PER VITI IN ACCIAIO CV

EXPERT

- Numero 1: 3-6,5mm
- Numero 2: 6,5-8mm
- Numero 3: 8-11mm
- Numero 4: 11-14mm
- Numero 5: 14-18mm

Per l'estrazione di viti
Utilizzabile con chiavi a rubinetto



Art.	N° pezzi	Ø	EAN	📦
49444300	5	3-18mm	4009314423004	5

SET

EINHELL SET DI PUNTE HSS-G CON RIVESTIMENTO IN TITANIO PER METALLO - 6PZ.

PROFESSIONAL

- Set completo
- Angolo di taglio 135°
- Finitura di alta qualità
- Rettifica trasversale
- Titanio dorato

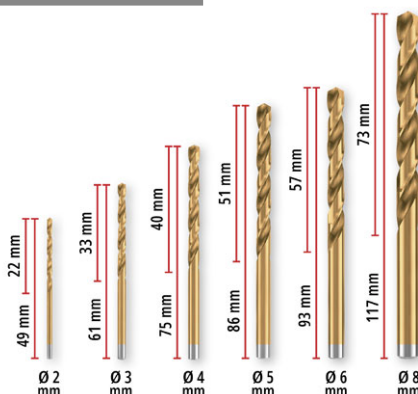

Art.	N° pezzi	Ø	EAN	📦
49427006	6	2-8mm	4009312270068	5

EINHELL SET DI PUNTE HSS-G CON RIVESTIMENTO IN TITANIO PER METALLO - 13PZ.



PROFESSIONAL

- Set completo
- Angolo di taglio 135°
- Finitura di alta qualità
- Rettifica trasversale
- Titanio dorato

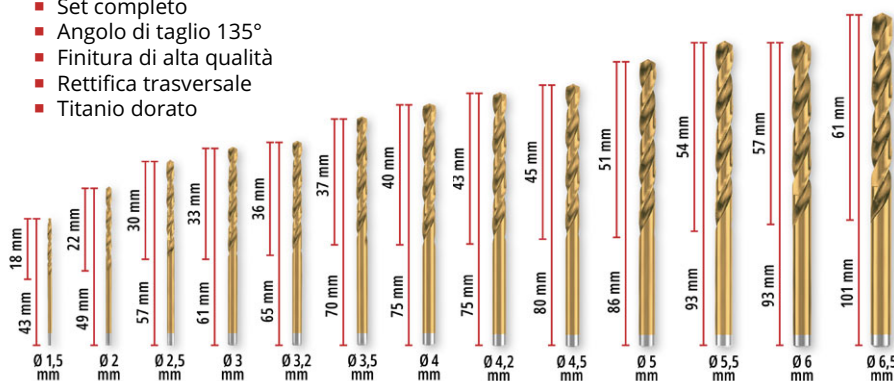

Art.	N° pezzi	Ø	EAN	📦
49427013	13	1.5-6.5mm		5

EINHELL SET DI PUNTE HSS-G CON RIVESTIMENTO IN TITANIO PER METALLO - 19PZ.



PROFESSIONAL

- Set completo
- Angolo di taglio 135°
- Finitura di alta qualità
- Rettifica trasversale
- Titanio dorato

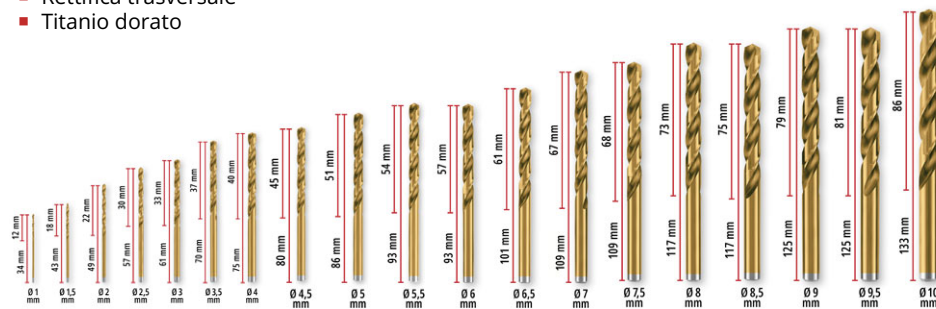

Art.	N° pezzi	Ø	EAN	📦
49427019	19	1-10mm		1

EINHELL SET DI PUNTE SILVER STAR HSS-G PER METALLO - 6PZ.



EXPERT

- Angolo di taglio 135°
- Finitura trasversale
- Rettifica di precisione
- Set completo

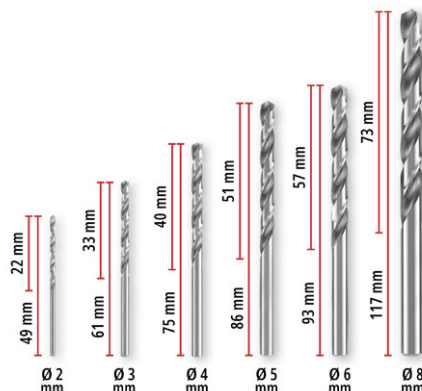

Art.	N° pezzi	Ø	EAN	📦
49205506	6	2-8mm		5

PUNTE PER METALLO

EINHELL SET DI PUNTE SILVER STAR HSS-G PER METALLO - 13PZ.



EXPERT

- Angolo di taglio 135°
- Finitura trasversale
- Rettifica di precisione
- Set completo

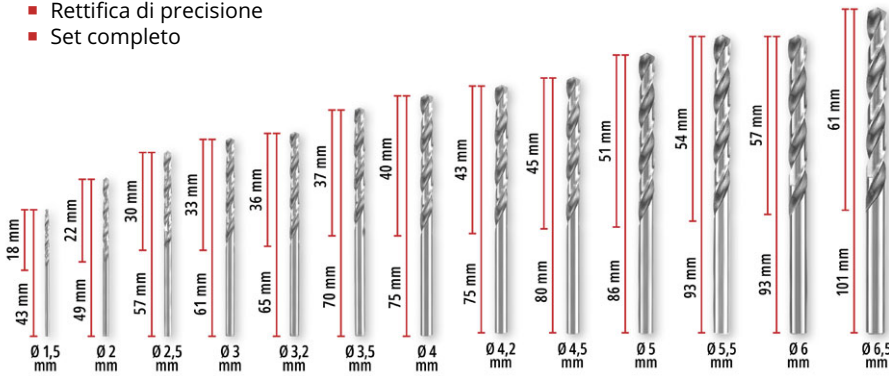

Art.	N° pezzi	Ø	EAN	📦
4920513	13	1.5-6.5mm		5

EINHELL SET DI PUNTE SILVER STAR HSS-G PER METALLO - 19PZ.



EXPERT

- Angolo di taglio 135°
- Finitura trasversale
- Rettifica di precisione
- Set completo

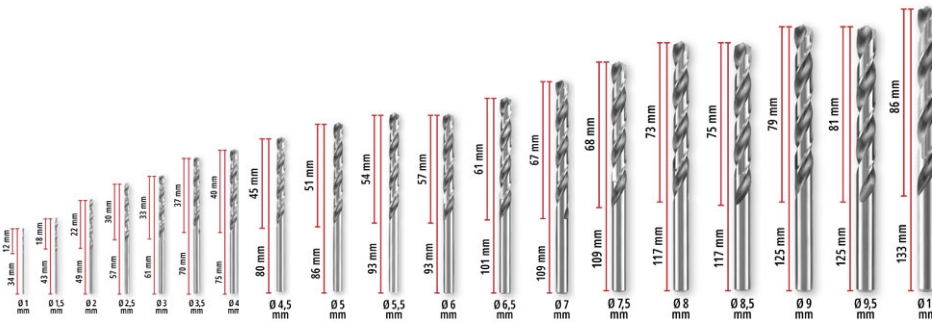

Art.	N° pezzi	Ø	EAN	📦
4920519	19	1-10mm		1

EINHELL SET DI PUNTE HSS-G PER METALLO - 6PZ.



CLASSIC

- Set completo
- Ottimo rapporto qualità-prezzo
- Angolo di taglio 118°
- Laminatura a rullo

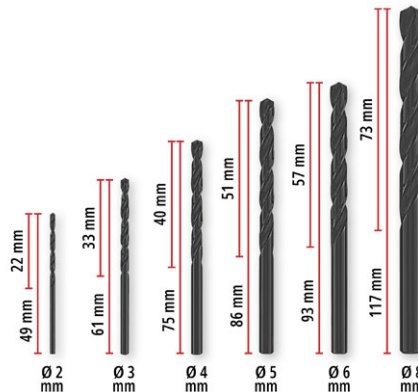

Art.	N° pezzi	Ø	EAN	📦
49423006	6	2-8mm		5

EINHELL SET DI PUNTE HSS-G PER METALLO - 13PZ.

CLASSIC

- Set completo
- Ottimo rapporto qualità-prezzo
- Angolo di taglio 118°
- Laminatura a rullo

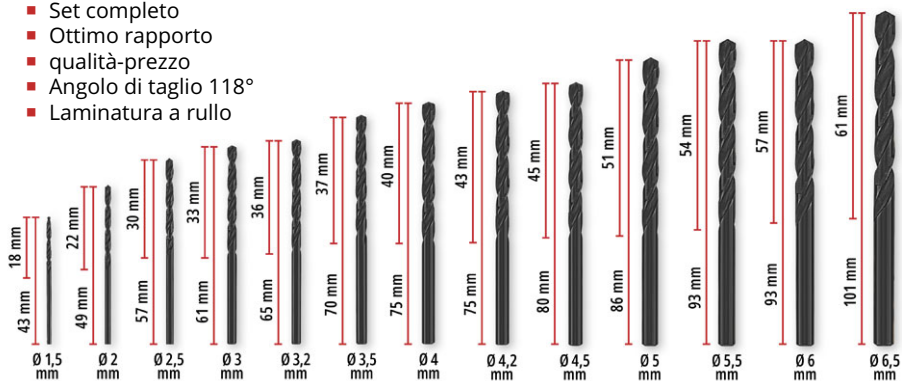

Art.	N° pezzi	Ø	EAN	
49423013	13	1.5-6.5mm		5

EINHELL SET DI PUNTE HSS-G PER METALLO - 19PZ.

CLASSIC

- Set completo
- Ottimo rapporto qualità-prezzo
- Angolo di taglio 118°
- Laminatura a rullo

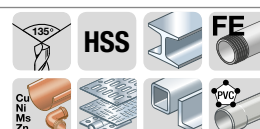
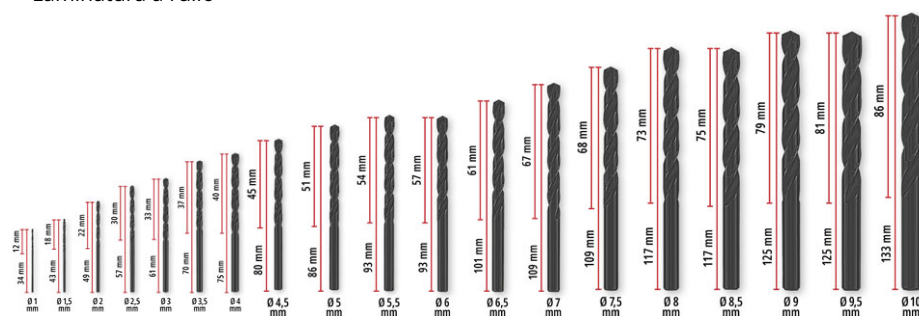

Art.	N° pezzi	Ø	EAN	
49423019	19	1-10mm		5

SET DI PUNTE PER METALLO CODOLO ESAGONALE - 10PZ.

EXPERT

- Set completo
- Codolo esagonale

Per metallo, alluminio e metalli non-ferrosi



Art.	N° pezzi	Ø	EAN	
49108723	10	2,0 - 6,5mm		1

SET DI MINI PUNTE DI PRECISIONE IN ACCIAIO HSS RIVESTITO AL TITANIO PER METALLO

PROFESSIONAL

- Angolo di taglio 135°

Per acciaio, metallo, lamiera, bronzo
alluminio, plastica e PVC
Per lavori di precisione

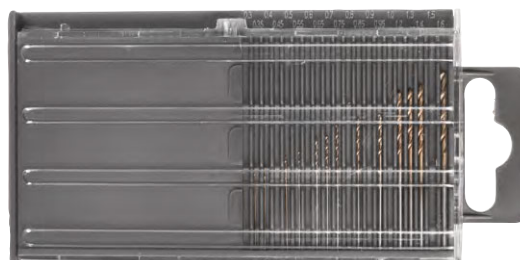

Art.	N° pezzi	Ø	EAN	
49424290	20	0,3-1,6mm		10

GUIDA PER LA FORATURA 4-12 MM

PROFESSIONAL



Art.	N° pezzi	Ø	EAN	
49757900	90°	4-12mm		3

PUNTE PER LEGNO



PUNTE PER LEGNO

PUNTE ELICOIDALI PER LEGNO

EXPERT

- Con punta di centraggio
- Doppia spirale
- Acciaio CV

Per legni duri e teneri



CV



Art.	Ø	Lunghezza lavoro	Lunghezza totale	EAN	📦
49511463	3,0mm	30mm	60mm	4009315114637	10
49511464	4,0mm	37mm	75mm	4009315114642	10
49511465	5,0mm	45mm	86mm	4009315114651	10
49511466	6,0mm	50mm	95mm	4009315114668	10
49511468	8,0mm	60mm	115mm	4009315114682	10
49511470	10,0mm	80mm	120mm	4009315114705	10
49511472	12,0mm	90mm	150mm	4009315114729	5
49511474	14,0mm	100mm	160mm	4009315114743	5
49511475	15,0mm	100mm	160mm	4009315114750	5
49511476	16,0mm	100mm	160mm	4009315114767	5
49511477	17,0mm	100mm	160mm	4009315114774	1



PUNTE ELICOIDALI PER LEGNO 250MM

EXPERT

- Con punta di centraggio
- Doppia spirale
- Acciaio CV

Per legni duri e teneri



Art.	Ø	Lunghezza lavoro	Lunghezza totale	EAN	📦
49511806	6,0mm	185mm	250mm	4009315118062	5
49511808	8,0mm	185mm	250mm	4009315118086	5
49511810	10,0mm	185mm	250mm	4009315118109	5
49511812	12,0mm	185mm	250mm	4009315118123	5
49511814	14,0mm	185mm	250mm	4009315118147	5
49511816	16,0mm	185mm	250mm	4009315118161	5
49511818	18,0mm	185mm	250mm	4009315118185	5
49511820	20,0mm	185mm	250mm	4009315118208	5

CV



SET DI PUNTE ELICOIDALI PER LEGNO 250MM - 3PZ.



CLASSIC

- Lunghezza totale 250 mm
- Punta in HSS-M2

Per legni duri e teneri



Art.	N°pezzi	Ø	EAN	📦
49511890	3	6, 8, 10mm		5

PUNTA ELICOIDALE PER LEGNO E TRAVI CON CODOLO ESAGONALE 235MM

CV



EXPERT

- Con punta di centraggio
- Acciaio CV
- Codolo esagonale

Spirale per estrazione rapida materiale



Art.	Ø	Lunghezza lavoro	Lunghezza totale	EAN	📦
49042206	6,0mm	160mm	235mm		5
49042208	8,0mm	160mm	235mm		5
49042210	10,0mm	160mm	235mm		5
49042212	12,0mm	160mm	235mm		5
49042214	14,0mm	160mm	235mm		5
49042216	16,0mm	160mm	235mm		5
49042218	18,0mm	160mm	235mm		5
49042220	20,0mm	160mm	235mm		5
49042222	22,0mm	160mm	235mm		5
49042224	24,0mm	160mm	235mm		5
49042226	26,0mm	160mm	235mm		5



PUNTA ELICOIDALE PER LEGNO E TRAVI CON CODOLO ESAGONALE 460MM



EXPERT

- Con punta di centraggio
- Acciaio CV
- Codolo esagonale

Spirale per estrazione rapida materiale



Art.	Ø	Lunghezza lavoro	Lunghezza totale	EAN	📦
49042406	6,0mm	390mm	460mm	4009310424029	1
49042408	8,0mm	390mm	460mm	4009310424033	1
49042410	10,0mm	390mm	460mm	4009310424106	1
49042412	12,0mm	390mm	460mm	4009310424120	1
49042414	14,0mm	390mm	460mm	4009310424124	1
49042416	16,0mm	390mm	460mm	4009310424118	1
49042418	18,0mm	390mm	460mm	4009310424113	1
49042420	20,0mm	390mm	460mm	4009310424205	1
49042422	22,0mm	390mm	460mm	4009310424229	1
49042424	24,0mm	390mm	460mm	4009310424243	1
49042426	26,0mm	390mm	460mm	4009310424227	1



MECCHE PER LEGNO

MECCHE PER LEGNO CON CODOLO ESAGONALE



EXPERT

- Due punte pre-taglio
- Codolo esagonale
- Rettifica precisa



Art.	Ø	Codolo	Lunghezza totale	EAN	📦
49512406	6,0mm	E 6.3	150mm	4009315124023	5
49512408	8,0mm	E 6.3	150mm	4009315124027	5
49512410	10,0mm	E 6.3	150mm	4009315124100	5
49512412	12,0mm	E 6.3	150mm	4009315124124	5
49512413	13,0mm	E 6.3	150mm	4009315124131	5
49512414	14,0mm	E 6.3	150mm	4009315124128	5
49512416	16,0mm	E 6.3	150mm	4009315124122	5
49512418	18,0mm	E 6.3	150mm	4009315124116	5
49512419	19,0mm	E 6.3	150mm	4009315124103	5
49512420	20,0mm	E 6.3	150mm	4009315124209	5
49512422	22,0mm	E 6.3	150mm	4009315124223	5
49512424	24,0mm	E 6.3	150mm	4009315124247	5
49512425	25,0mm	E 6.3	150mm	4009315124254	5
49512426	26,0mm	E 6.3	150mm	4009315124221	5
49512428	28,0mm	E 6.3	150mm	4009315124225	5
49512430	30,0mm	E 6.3	150mm	4009315124308	5
49512432	32,0mm	E 6.3	150mm	4009315124322	5
49512434	34,0mm	E 6.3	150mm	4009315124346	5
49512435	35,0mm	E 6.3	150mm	4009315124353	5
49512438	38,0mm	E 6.3	150mm	4009315124384	5
49512440	40,0mm	E 6.3	150mm	4009315124407	5



PROLUNGA PER MECCHE



EXPERT

- Uso con meccchie a codolo esagonale
- Con chiave di serraggio



Art.	Codolo	Lunghezza totale	EAN	📦
49512450	E 6.3	300mm	4009315124502	1



PUNTE PER CERNIERE E FORI CIECHI

PUNTA FORSTNER

CLASSIC

- 2 taglienti principali
- 2 taglienti laterali
- Acciaio speciale trattato

*Per cerniere e fori ciechi
Adatte a legni duri,
legni teneri e truciolati*



Art.	Ø	Lunghezza lavoro	Lunghezza totale	EAN	📦
49706515	15,0mm	9,5mm	93mm		5
49706520	20,0mm	9,5mm	93mm		5
49706522	22,0mm	9,5mm	93mm		5
49706526	26,0mm	9,5mm	93mm		5
49706530	30,0mm	9,5mm	93mm		5
49706535	35,0mm	9,5mm	93mm		5
49706540	40,0mm	9,5mm	93mm		5
49706545	45,0mm	9,5mm	93mm		5



PUNTA PER COMPENSATO E CERNIERE IN LEGNO

EXPERT

*Per legno duro,
tenero e compensato*

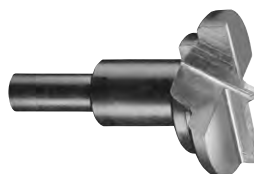

Art.	Ø	Ø Codolo	EAN	📦
49705510	26 mm	8 mm		6
49705520	30 mm	8 mm		6
49705530	35 mm	8 mm		6



SVASATORI

PUNTE A SVASARE PER LEGNO CON CHIAVE DI SERRAGGIO

EXPERT

*Per legni duri e teneri,
MDF, truciolato*



Art.	Ø	Ø svasatore	Angolo svasatore	EAN	📦
49513103	3,0mm	10mm	90°	4009315131030	5
49513104	4,0mm	12mm	90°	4009315131040	5
49513105	5,0mm	13mm	90°	4009315131050	5
49513106	6,0mm	13mm	90°	4009315131060	5

SET SVASATORI PER LEGNO CON CHIAVE DI SERRAGGIO - 8PZ.

CLASSIC

- Acciaio C45
- Punta a 4 taglienti
- Profondità regoalibile

*Per legni duri e teneri,
MDF, truciolato*



Art.	N°pezzi	Ø	Prof. di taglio	EAN	📦
49513190	8	3-6mm	regolabile	4009315131900	6

SVASATORE PER LEGNO HSS 7 TAGLIENTI

EXPERT

- Svasatura a 90°

Per legno e metalli non-ferrosi



Art.	Ø	Ø Codolo	EAN	📦
49704210	8 mm	8 mm	4009317021010	6
49704310	12 mm	8 mm	4009317023102	6
49704410	16 mm	8 mm	4009317024109	6

SET DI SVASATORI - 3PZ.

EXPERT

- Svasatura a 90°

Per legno e metalli non-ferrosi



Art.	N°pezzi	Ø	Prof. di taglio	EAN	📦
49511100	3	8,12,16mm	6-8mm	4009315111001	6

SET

EINHELL SET DI PUNTE PER LEGNO CODOLO ESAGONALE - 10PZ.



EXPERT

- Con punta di centraggio
- Doppia spirale
- Acciaio CV
- Codolo esagonale

Per legni duri e teneri



Art.	N°pezzi	Ø	EAN	
49108733	10	3, 4, 5, 6, 7, 8mm		5

SET PUNTE ELICOIDALI PER LEGNO - 5PZ.



EXPERT

- Con punta di centraggio
- Doppia spirale
- Acciaio CV

Per legni duri e teneri



Art.	N°pezzi	Ø	EAN	
49514000	5	4, 5, 6, 8, 10mm		6

SET PUNTE ELICOIDALI PER LEGNO - 8PZ.



EXPERT

- Con punta di centraggio
- Doppia spirale
- Acciaio CV

Per legni duri e teneri



Art.	N°pezzi	Ø	EAN	
49514100	8	3, 4, 5, 6, 7, 8, 9, 10mm		6

SET PUNTE ELICOIDALI PER LEGNO E SVASATORE - 7PZ.



EXPERT

- Con punta di centraggio
- Doppia spirale

Per legni duri e teneri con svasatore da 12mm



Art.	N°pezzi	Ø	EAN	
49514200	7	3, 4, 5, 6, 8, 10, Svasatore 12mm		6

SET DI PUNTE PER LEGNO - 5PZ.

CLASSIC

- Con punta di centraggio
- Doppia spirale

Per legni duri e teneri



Art.	N°pezzi	Ø	EAN	
49109135	5	4, 5, 6, 8, 10mm	4009311091352	8

SET DI MECCHIE PER LEGNO - 7PZ.

EXPERT

- Due punte pre-taglio
- Codolo esagonale
- Rettifica precisa



Art.	N°pezzi	Ø	EAN	
49512250	7	10, 12, 16, 18, 20, 22, 24mm	4009315122502	2

SET MECCHIE PER LEGNO - 6PZ.

CLASSIC

- 2 punte per pre-taglio
- Codolo esagonale
- Rapporto qualità-prezzo



Art.	N°pezzi	Ø	EAN	
49512490	6	49512490	4009315124902	6

SET PUNTE FORSTNER - 3PZ.

CLASSIC

- 2 taglienti principali
- 2 taglienti laterali
- Acciaio speciale trattato

*Per cerniere e fori ciechi
Adatte a legni duri,
legni teneri e truciolati*



Art.	N°pezzi	Ø	Profondità di taglio	EAN	
49706593	3	20, 35, 40mm	93mm	4009317065932	1

SET PUNTE FORSTNER - 5PZ.

CLASSIC

- 2 taglienti principali
- 2 taglienti laterali
- Acciaio speciale trattato

*Per cerniere e fori ciechi
Adatte a legni duri,
legni teneri e truciolati*



Art.	N°pezzi	Ø	Profondità di taglio	EAN	
49706595	5	15, 20, 25, 30, 35mm	93mm	4009317065952	1

FRESE A TAZZA



FRESE A TAZZA PER LEGNO E METALLO

FRESA A TAZZA HSS 8% COBALTO PER METALLO E ACCIAIO INOX



PROFESSIONAL

- 8% Cobalto
- Dentatura progressiva
- Punte cilindriche e SDS

Per acciaio inox, lamiera, metallo ghisa, alluminio, bronzo, rame, ottone, plastica e legno



Art.	Ø	Profondità di taglio	EAN	📦
49598016	16mm	38mm	4009315980124	1
49598019	19mm	38mm	4009315980193	1
49598020	20mm	38mm	4009315980201	1
49598022	22mm	38mm	4009315980223	1
49598025	25mm	38mm	4009315980252	1
49598029	29mm	38mm	4009315980294	1
49598030	30mm	38mm	4009315980300	1
49598032	32mm	38mm	4009315980324	1
49598035	35mm	38mm	4009315980355	1
49598038	38mm	38mm	4009315980382	1
49598040	40mm	38mm	4009315980409	1
49598041	41mm	38mm	4009315980416	1





Art.	Ø	Profondità di taglio	EAN	📦
49598044	44mm	60mm	4009315980447	1
49598046	46mm	60mm	4009315980461	1
49598048	48mm	60mm	4009315980485	1
49598051	51mm	60mm	4009315980515	1
49598054	54mm	60mm	4009315980546	1
49598057	57mm	60mm	4009315980577	1
49598060	60mm	60mm	4009315980607	1
49598064	64mm	60mm	4009315980645	1
49598065	65mm	60mm	4009315980652	1
49598067	67mm	60mm	4009315980676	1
49598068	68mm	60mm	4009315980683	1
49598070	70mm	60mm	4009315980706	1
49598073	73mm	60mm	4009315980737	1
49598076	76mm	60mm	4009315980768	1
49598079	79mm	60mm	4009315980799	1
49598083	83mm	60mm	4009315980832	1
49598089	89mm	60mm	4009315980893	1
49598092	92mm	60mm	4009315980928	1
49598095	95mm	60mm	4009315980959	1
49598102	102mm	60mm	4009315981024	1
49598105	105mm	60mm	4009315981055	1
49598111	111mm	60mm	4009315981116	1
49598114	114mm	60mm	4009315981147	1
49598121	121mm	60mm	4009315981215	1
49598127	127mm	60mm	4009315981277	1
49598152	152mm	60mm	4009315981529	1

SISTEMA DI CENTRAGGIO PER FRESE DA 16 A 32MM

HSS

PROFESSIONAL

- Filettatura universale per frese 1/2" 20 UNF
- Disponibile in SDS Plus
- Portapunte 10 e 13 mm



Art.	Ø	Codolo	EAN	📦
49598800	16-32mm	Hex 9,5mm	4009315988800	4
49598400	16-32mm	SDS Plus	4009315988400	4

SISTEMA DI CENTRAGGIO PER FRESE DA 32 A 152MM

HSS

PROFESSIONAL

- Filettatura universale per frese 5/8" 18 UNF
- Disponibile in SDS Plus
- Portapunte da 10 e 13 mm



Art.	Ø	Codolo	EAN	📦
49598900	32-152mm	Hex 9,5mm	4009315989000	4
49598500	32-152mm	SDS Plus	4009315985008	4

PUNTA DI CENTRAGGIO

HSS



PROFESSIONAL

- Acciaio HSS
- Ricambio per centraggio



Art.	Ø	Lunghezza totale	EAN	📦
49598700	6,35mm	82mm	4009315987002	6

FRESA A TAZZA BIMETALLICA CON GAMBO E PUNTA

HSS
BIM

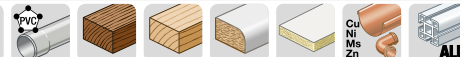

EXPERT

- Con punta di centraggio
- Codolo esagonale

*Per alluminio, lamiera,
metalli non ferrosi,
legno, cartongesso e PVC*



Art.	Ø	Profondità di taglio	EAN	📦
49598720	20 mm	38 mm	4009315987200	4
49598722	22 mm	38 mm	4009315987224	4
49598725	25 mm	38 mm	4009315987255	4
49598729	29 mm	38 mm	4009315987293	4
49598732	32 mm	38 mm	4009315987323	2
49598735	35 mm	38 mm	4009315987354	2
49598740	40 mm	38 mm	4009315987408	2
49598745	45 mm	38 mm	4009315987453	2
49598751	51 mm	38 mm	4009315987514	2
49598756	56 mm	38 mm	4009315987569	2
49598765	65 mm	38 mm	4009315987651	2
49598768	68 mm	38 mm	4009315987682	2
49598774	74 mm	38 mm	4009315987743	2
49598783	83 mm	38 mm	4009315987835	2
49598795	95 mm	38 mm	4009315987958	2



FRESA A TAZZA MULTICORONA AD ALTO RENDIMENTO

PROFESSIONAL

- Piatto d'appoggio zinco
- Punta temprata a induzione



Art.	Ø	Prof. di taglio	N° corone	EAN	📦
49498920	25, 32, 38, 44, 51, 57, 63, 68mm	28mm	8	40093142989205	2
49498720	46, 53, 59, 66, 73, 82, 94mm	30mm	7	40093142987201	2



FRESA A TAZZA MULTICORONA

EXPERT

- Piatto d'appoggio zinco
- Punta temprata a induzione



Art.	Ø	Prof. di taglio	N° corone	EAN	📦
49498800	46, 53, 60, 68, 74, 81mm	32mm	6	40093142988000	2
49499700	68, 74, 80, 90mm	32mm	4	40093142997002	2



FRESA A TAZZA MULTICORONA

CLASSIC

- Piatto in alluminio duro
- Denti in acciaio indurito



Art.	Ø	Prof. di taglio	N° corone	EAN	📦
49599100	25, 32, 38, 45, 50, 58, 63mm	40mm	7	40093145991009	2



FRESA A TAZZA MULTICORONA

CLASSIC

- Piatto in alluminio duro
- Denti in acciaio indurito



Art.	Ø	Prof. di taglio	N° corone	EAN	📦
49498500	28, 35, 50, 68, 75mm	30mm	5	40093142985009	2



SET DI FRESE A TAZZA BIMETALLICHE HSS - 5PZ.



CLASSIC

- Punta di centraggio HSS
- Dentatura progressiva



Per legno, cartongesso, compensato, truciolato e plastica

Art.	Ø	Prof. taglio	N°corone	EAN	📦
49109178	68, 76, 89, 102mm	32mm	5		4

FRESE A TAZZA DIAMANTATE

FRESA A TAZZA DIAMANTATA PER CERAMICA E GRES CON CODOLO M14



PROFESSIONAL

- Cera lubrificante integrata (6-14mm)
- Segmento diamantato
- Alto rendimento
- Taglio a secco



Per gres porcellanato, ceramica, granito marmo, ardesia e piastrelle

Art.	Ø	Altezza segmento	Codolo	EAN	📦
49500206	6,0mm	10mm	M14		1
49500208	8,0mm	10mm	M14		1
49500210	10,0mm	10mm	M14		1
49500212	12,0mm	10mm	M14		1
49500214	14,0mm	10mm	M14		1
49500220	20,0mm	10mm	M14		1
49500225	25,0mm	10mm	M14		1
49500230	30,0mm	10mm	M14		1
49500235	35,0mm	10mm	M14		1
49500238	38,0mm	10mm	M14		1
49500240	40,0mm	10mm	M14		1
49500242	42,0mm	10mm	M14		1
49500245	45,0mm	10mm	M14		1
49500250	50,0mm	10mm	M14		1
49500268	68,0mm	10mm	M14		1

FRESA A TAZZA DIAMANTATA PER CERAMICA E GRES CON CODOLO ESAGONALE



PROFESSIONAL

- Cera lubrificante integrata
- Segmento diamantato
- Alto rendimento
- Taglio a secco

Per gres porcellanato, ceramica, granito



Art.	Ø	Altezza segmento	Codolo	EAN	📦
49500306	6,0mm	10mm	Hex E 6.3	4009315003061	1
49500308	8,0mm	10mm	Hex E 6.3	4009315003083	1
49500310	10,0mm	10mm	Hex E 6.3	4009315003108	1
49500312	12,0mm	10mm	Hex E 6.3	4009315003123	1
49500314	14,0mm	10mm	Hex E 6.3	4009315003148	1



EINHELL SET DI FRESE DIAMANTATE PER CERAMICA E GRES - 4PZ.



EXPERT

- Cera lubrificante integrata (6-14mm)
- Segmento diamantato
- Alto rendimento
- Taglio a secco

Per gres porcellanato, ceramica, granito marmo, ardesia e piastrelle

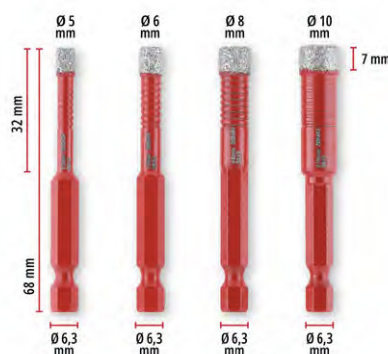

Art.	Ø	Altezza segmento	Codolo	EAN	📦
49500404	5, 6, 8, 10mm	7mm	Hex E 6.3	4009315004042	1



FRESA A TAZZA DIAMANTATA PER CERAMICA E GRES CON CODOLO ESAGONALE PER TAGLIO AD ACQUA



EXPERT

- Corpo tornito massiccio
- Precisione dimensionale
- Taglio ad acqua

*Per gres porcellanato, ceramica,
granito e piastrelle*



Art.	Ø	Altezza segmento	Codolo	EAN	📦
49499805	5,0mm	7mm	Hex 9,5mm	40093142998054	7
49499806	6,0mm	7mm	Hex 9,5mm	40093142998061	7
49499807	7,0mm	7mm	Hex 9,5mm	40093142998078	7
49499808	8,0mm	7mm	Hex 9,5mm	40093142998085	7
49499810	10,0mm	7mm	Hex 9,5mm	40093142998108	7
49499812	12,0mm	7mm	Hex 9,5mm	40093142998122	5
49499814	14,0mm	7mm	Hex 9,5mm	40093142998146	5
49499816	16,0mm	7mm	Hex 9,5mm	40093142998160	5
49499820	20,0mm	7mm	Hex 9,5mm	40093142998209	5
49499825	25,0mm	7mm	Hex 9,5mm	40093142998252	3
49499830	30,0mm	7mm	Hex 9,5mm	40093142998306	3
49499835	35,0mm	7mm	Hex 9,5mm	40093142998351	3
49499845	45,0mm	7mm	Hex 9,5mm	40093142998450	1
49499850	50,0mm	7mm	Hex 9,5mm	40093142998504	1
49499868	68,0mm	7mm	Hex 9,5mm	40093142998689	1
49499876	76,0mm	7mm	Hex 9,5mm	40093142998764	1



SISTEMA REFRIGERANTE PER FRESE A TAZZA

EXPERT

- Sistema con ventosa
- Recipiente per acqua
- Bottone per erogazione dell'acqua



Per ceramica, gres porcellanato
granito, marmo, cemento.
Per raffreddare le zone di taglio

Art.	Ø	EAN	
49499800	5-35mm		1



BITS E ACCESSORI PER AVVITATURA



TECNOLOGIA DOPPIA ZONA DI TORSIONE

Questa innovazione rappresenta un notevole passo avanti nella tecnologia degli inserti di avvitatura, pensata per ottimizzare le prestazioni degli avvitatori a impulsi.

VANTAGGI DELLA DOPPIA ZONA DI TORSIONE:

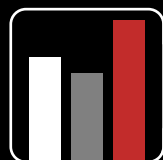

PRESTAZIONI SUPERIORI
SERRAGGIO SICURO E PRECISO



MAGGIORE DURATA E RESISTENZA
VITA UTILE PROLUNGATA



RIDUZIONE DELLE VIBRAZIONI
PIÙ COMFORT, MENO FATICA

PERCHÉ SCEGLIERE EINHELL:

Einhell continua a innovare per offrire prodotti di alta qualità che soddisfano le esigenze professionali. La nostra nuova linea di inserti con doppia zona di torsione è progettata per garantire efficienza, sicurezza e durabilità, rendendola una scelta ideale per chi utilizza avvitatori a impulsi.



BITS DOUBLE IMPACT

BITS CON DOPPIA ZONA DI TORSIONE PUNTA PHILIPS, 30-60-120 MM

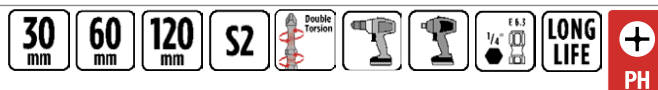

PROFESSIONAL

- Doppia zona di torsione
- Adatti all'uso continuo
- Durata massima
- Per avvitatura ad impulsi



Art.	Tipo	Lunghezza (mm)	N°pezzi	EAN	📦
49132010	PH1	30	2		5
49132020	PH2	30	2		5
49132030	PH3	30	2		5
49132130	PH2	60	2		5
49132210	PH2	120	1		5

BITS CON DOPPIA ZONA DI TORSIONE PUNTA POZIDRIVE, 30-60-120 MM

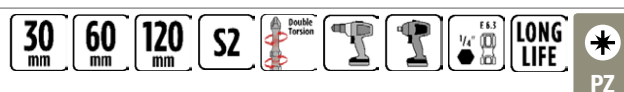

PROFESSIONAL

- Doppia zona di torsione
- Adatti all'uso continuo
- Durata massima
- Per avvitatura ad impulsi



Art.	Tipo	Lunghezza (mm)	N°pezzi	EAN	📦
49132040	PZ1	30	2		5
49132050	PZ2	30	2		5
49132060	PZ3	30	2		5
49132140	PZ2	60	2		5
49132220	PZ2	120	1		5

BITS CON DOPPIA ZONA DI TORSIONE PUNTA TORX, 30-60-120 MM

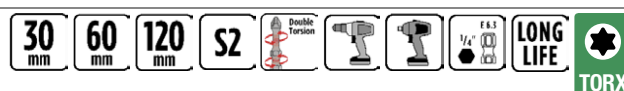

PROFESSIONAL

- Doppia zona di torsione
- Adatti all'uso continuo
- Durata massima
- Per avvitatura ad impulsi



Art.	Tipo	Lunghezza (mm)	N°pezzi	EAN	📦
49132070	T10	30	2		5
49132080	T15	30	2		5
49132090	T20	30	2		5
49132100	T25	30	2		5
49132110	T30	30	2		5
49132120	T40	30	2		5
49132150	T10	60	2		5
49132160	T15	60	2		5
49132170	T20	60	2		5
49132180	T25	60	2		5
49132190	T30	60	2		5
49132200	T40	60	1		5





Art.	Tipo	Lunghezza (mm)	N°pezzi	EAN	📦
49132230	T10	120	1	4009311322302	5
49132240	T15	120	1	4009311322401	5
49132250	T20	120	1	4009311322500	5
49132260	T25	120	1	4009311322609	5
49132270	T30	120	1	4009311322708	5
49132280	T40	120	1	4009311322807	5

BITS IMPACT

BITS CON ZONA DI TORSIONE PUNTA PHILIPS, 25-50-100 MM

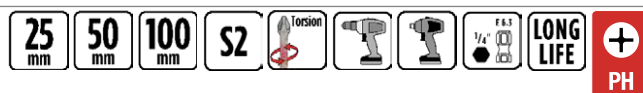

- Zona di torsione singola
- Per avvitatura ad impulsivi
- Molto resistenti



Art.	Tipo	Lunghezza (mm)	N°pezzi	EAN	📦
49131010	PH1	25	2	4009311310101	5
49131020	PH2	25	2	4009311310200	5
49131030	PH3	25	2	4009311310309	5
49131160	PH1	50	2	4009311311600	5
49131170	PH2	50	2	4009311311702	5
49131180	PH3	50	2	4009311311801	5
49131280	PH2	100	1	4009311312808	5

BITS CON ZONA DI TORSIONE PUNTA POZIDRIVE, 25-50-100 MM

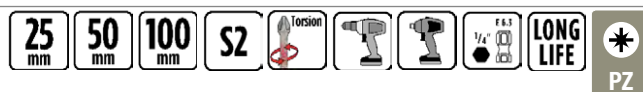

- Zona di torsione singola
- Per avvitatura ad impulsivi
- Molto resistenti



Art.	Tipo	Lunghezza (mm)	N°pezzi	EAN	📦
49131040	PZ1	25	2	4009311310408	5
49131050	PZ2	25	2	4009311310509	5
49131060	PZ3	25	2	4009311310600	5
49131190	PZ1	50	2	4009311311900	5
49131200	PZ2	50	2	4009311312002	5
49131210	PZ3	50	2	4009311312103	5
49131290	PZ2	100	1	4009311312909	5

BITS CON ZONA DI TORSIONE PUNTA POZIDRIVE, 25-50-100 MM

- Zona di torsione singola
- Per avvitatura ad impulsi
- Molto resistenti

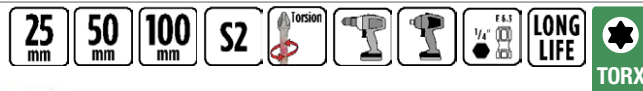

Art.	Tipo	Lunghezza (mm)	N°pezzi	EAN	📦
49131070	T10	25	2	4009511312001	5
49131080	T15	25	2	4009511310804	5
49131090	T20	25	2	4009511310903	5
49131100	T25	25	2	4009511311003	5
49131110	T30	25	2	4009511311108	5
49131120	T40	25	2	4009511311207	5
49131220	T10	50	2	4009511312204	5
49131230	T15	50	2	4009511312303	5
49131240	T20	50	2	4009511312403	5
49131250	T25	50	2	4009511312501	5
49131260	T30	50	2	4009511312600	5
49131270	T40	50	2	4009511312709	5
49131300	T10	100	1	4009511313003	5
49131310	T15	100	1	4009511313102	5
49131320	T20	100	1	4009511313201	5
49131330	T25	100	1	4009511313300	5
49131340	T30	100	1	4009511313409	5

BITS CON ZONA DI TORSIONE PUNTA ESAGONALE 25 MM

- Zona di torsione singola
- Per avvitatura ad impulsi
- Molto resistenti

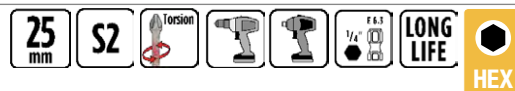

Art.	Tipo	Lunghezza (mm)	N°pezzi	EAN	📦
49131130	3mm	25	2	4009511311302	5
49131140	4mm	25	2	4009511311405	5
49131150	5mm	25	2	4009511311504	5

SET DI BITS CON ZONA DI TORSIONE, 5 - 7PZ.



Art.	Tipo	Lunghezza (mm)	N°pezzi	EAN	📦
49131360	PH2-3, PZ1-2, SL5	25	5	4009511313600	5
49131370	T10-T15-T20- T25-T27- T30-T40	25	7	4009511313702	5



BITS STANDARD

BITS STANDARD PUNTA PHILIPS, 25-50 MM

■ Acciaio CV

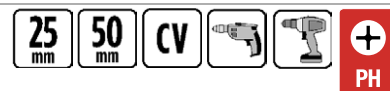

Art.	Tipo	Lunghezza (mm)	N°pezzi	EAN	📦
49130010	PH1	25	3	4009311300102	5
49130020	PH2	25	3	4009311300201	5
49130030	PH3	25	3	4009311300300	5
49130290	PH1	50	3	4009311302908	5
49130300	PH2	50	3	4009311303004	5
49130310	PH3	50	3	4009311303103	5

BITS STANDARD PUNTA POZIDRIVE, 25-50 MM

■ Acciaio CV

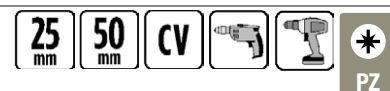

Art.	Tipo	Lunghezza (mm)	N°pezzi	EAN	📦
49130040	PZ1	25	3	4009311300409	5
49130050	PZ2	25	3	4009311300508	5
49130060	PZ3	25	3	4009311300607	5
49130070	PZ4	25	3	4009311300706	5
49130320	PZ1	50	3	4009311303202	5
49130330	PZ2	50	3	4009311303301	5
49130340	PZ3	50	3	4009311303400	5

BITS STANDARD PUNTA TORX, 25-50 MM



■ Acciaio CV



Art.	Tipo	Lunghezza (mm)	N°pezzi	EAN	
49130110	T6	25	3		5
49130120	T7	25	3		5
49130130	T8	25	3		5
49130140	T9	25	3		5
49130150	T10	25	3		5
49130160	T15	25	3		5
49130170	T20	25	3		5
49130180	T25	25	3		5
49130190	T27	25	3		5
49130200	T30	25	3		5
49130210	T40	50	3		5
49130350	T10	50	3		5
49130360	T15	50	3		5
49130370	T20	50	3		5
49130380	T25	50	3		5
49130390	T30	50	3		5
49130400	T40	50	3		5

BITS STANDARD PUNTA SLOT, 25 MM



■ Acciaio CV



Art.	Tipo	Lunghezza (mm)	N°pezzi	EAN	
49130080	4mm	25	3		5
49130090	5mm	25	3		5
49130100	6mm	25	3		5

BITS STANDARD PUNTA ESAGONALE, 25 MM



■ Acciaio CV



Art.	Tipo	Lunghezza (mm)	N°pezzi	EAN	
49130220	2,5mm	25	3		5
49130230	3mm	25	3		5
49130240	4mm	25	3		5
49130250	5mm	25	3		5
49130260	5,5mm	25	3		5
49130270	6mm	25	3		5
49130280	8mm	25	3		5

BITS E ACCESSORI PER AVVITATURA

BITS STANDARD PUNTA DOPPIA, 65 MM

■ Acciaio CV

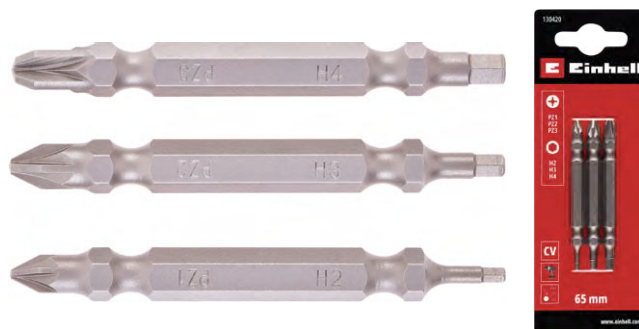
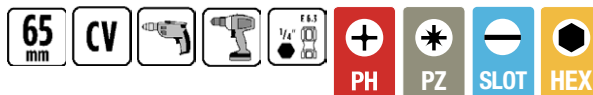

Art.	Tipo	Lunghezza (mm)	N°pezzi	EAN	📦
49130410	PH1-2-3 SL 4-5-6	65	3		5
49130420	PZ1-2-3 HEX 2-3-4	65	3		5

BITS STANDARD IN ACCIAIO S2 CON ARRESTO DI PROFONDITÀ PER CARTONGESSO PH2, 25 MM

■ Robusto acciaio S2



Art.	Tipo	Lunghezza (mm)	N°pezzi	EAN	📦
49131350	PH2	25	2		5
49104610	PZ2	25	2		6

SET DI BITS STANDARD 50MM CON PROLUNGA FLESSIBILE - 11PZ.

■ Acciaio CV

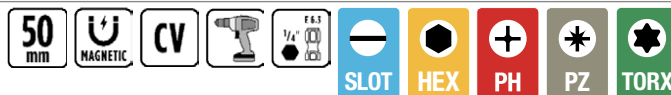

Art.	Tipo	Lunghezza (mm)	N°pezzi	EAN	📦
49133115	1/4" E 6.3 PH-PZ-TORX-SLOT-HEX	300	300		5



PORTABIT

PORTABIT A SGANCIO RAPIDO, MAGNETICO 1/4" 60MM



Art.	Gambo	Lunghezza (mm)	Qualità	EAN	
49133105	1/4" E 6.3	60	Standard		5

PORTABIT A SGANCIO RAPIDO, MAGNETICO IMPACT 1/4" 65MM



- Zona di torsione singola
- Per avvitatura ad impulsi
- Molto resistenti



Art.	Gambo	Lunghezza (mm)	Qualità	EAN	
49133205	1/4" E 6.3	65	Impact		5

PORTABIT A SGANCIO RAPIDO, MAGNETICO DOUBLE IMPACT 1/4" 75MM S2



PROFESSIONAL

- Doppia zona di torsione
- Adatti all'uso continuo
- Durata massima
- Per avvitatura ad impulsi



Art.	Gambo	Lunghezza (mm)	Qualità	EAN	
49133300	1/4" E 6.3	75	Double Impact		5

PORTABIT CORTO "SHORTY" 3/8" 35MM



Art.	Gambo	Lunghezza (mm)	Qualità	EAN	📦
49133100	HEX 3/8"	35	Standard		5

PORTABIT MAGNETICO 1/4" 60MM



Art.	Gambo	Lunghezza (mm)	Qualità	EAN	📦
49133110	1/4" E 6.3	60	Standard		5

PORTABIT MAGNETICO 1/4" 60MM CR-V INOX



Art.	Gambo	Lunghezza (mm)	Qualità	EAN	📦
49133225	1/4" E 6.3	60	Standard		5

PORTABIT MAGNETICO LUNGO GAMBO 1/4" IMPACT



- Zona di torsione singola
- Per avvitatura ad impulsi
- Molto resistenti

Art.	Gambo	Lunghezza (mm)	Qualità	EAN	📦
49133210	1/4" E 6.3	75	Impact		5
49133235	1/4" E 6.3	150	Impact		5
49133240	1/4" E 6.3	200	Impact		5

PORTABIT MAGNETICO DOUBLE IMPACT 1/4" 75MM S2



PROFESSIONAL

- Doppia zona di torsione
- Adatti all'uso continuo
- Durata massima
- Per avvitatura ad impulsi



Art.	Gambo	Lunghezza (mm)	Qualità	EAN	📦
49133305	1/4" E 6.3	75	Double Impact		5

PORTABIT CON GUIDA PER VITE MAGNETICO 80MM



Art.	Gambo	Lunghezza (mm)	Qualità	EAN	
49133200	1/4" E 6.3	80-122	Standard		5

PORTABIT PIVOTALE TRIPLE-FIX 1/4" 90MM



Art.	Gambo	Lunghezza (mm)	Materiale	EAN	
49133230	1/4" E 6.3	90	SCM440		5

PORTABIT CON ATTACCO SDS PLUS



Art.	Gambo	Lunghezza (mm)	Qualità	EAN	
49133220	SDS Plus	75	Cr-V e Inox		5

ADATTATORE PER AVVITATURA ANGOLARE 90°

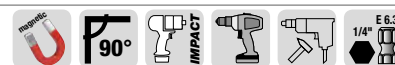

PROFESSIONAL

- Manico ergonomico
- Adatto all'avvitatura a impuls



Art.	Gambo	Angolo	EAN	
49118410	E6.3 1/4"	90°		6

ADATTATORE PER AVVITATURA ANGOLARE 90°



EXPERT

- Manico semplice



Art.	Gambo	Angolo	EAN	
49118100	C6.3 1/4"	90°		6



CHIAVI A BUSSOLA E ADATTATORI

BUSSELE A MACCHINA IMPACT ATTACCO QUADRO 1/2"

- Acciaio Cromo-Molibdeno fosfatato al manganese
- Adatto a reggere carichi elevati dell'avvitatura ad impulsi



Art.	Attacco	Uscita	Qualità	EAN	📦
49135310	■ 1/2"	● 10mm	Impact	4009311353108	6
49135311	■ 1/2"	● 11mm	Impact	4009311353113	6
49135312	■ 1/2"	● 12mm	Impact	4009311353122	6
49135313	■ 1/2"	● 13mm	Impact	4009311353139	6
49135314	■ 1/2"	● 14mm	Impact	4009311353142	6
49135315	■ 1/2"	● 15mm	Impact	4009311353153	6
49135316	■ 1/2"	● 16mm	Impact	4009311353160	6
49135317	■ 1/2"	● 17mm	Impact	4009311353177	6
49135318	■ 1/2"	● 18mm	Impact	4009311353184	6
49135319	■ 1/2"	● 19mm	Impact	4009311353191	6
49135320	■ 1/2"	● 20mm	Impact	4009311353209	6
49135321	■ 1/2"	● 21mm	Impact	4009311353214	6
49135322	■ 1/2"	● 22mm	Impact	4009311353221	6
49135324	■ 1/2"	● 24mm	Impact	4009311353243	6
49135327	■ 1/2"	● 27mm	Impact	4009311353270	6
49135330	■ 1/2"	● 30mm	Impact	4009311353302	6
49135332	■ 1/2"	● 32mm	Impact	4009311353320	6



SNODO REGOLABILE QUADRO 1/2" IMPACT

- Angolo max. 30°



Art.	Attacco	Uscita	Qualità	EAN	📦
49135300	■ 1/2"	■ 1/2"	Impact	4009311353009	6

CHIAVI A BUSSOLA MAGNETICHE CON FUNZIONE A IMPULSI, 67MM



- Per avvitatura a impulsi
- Magnetiche
- Molto resistenti

Art.	Gambo	Ø	Qualità	EAN	📦
49135205	1/4" E 6.3	6	Impact	4009311352059	5
49135210	1/4" E 6.3	7	Impact	4009311352109	5
49135215	1/4" E 6.3	8	Impact	4009311352159	5
49135220	1/4" E 6.3	10	Impact	4009311352209	5
49135225	1/4" E 6.3	11	Impact	4009311352259	5
49135230	1/4" E 6.3	12	Impact	4009311352309	5
49135235	1/4" E 6.3	13	Impact	4009311352359	5



CHIAVI A BUSSOLA IN ACCIAIO CV, 48MM



Art.	Gambo	Ø	Qualità	EAN	📦
49135105	1/4" E 6.3	5,5	Standard	4009311351059	5
49135110	1/4" E 6.3	6	Standard	4009311351109	5
49135115	1/4" E 6.3	7	Standard	4009311351159	5
49135120	1/4" E 6.3	8	Standard	4009311351209	5
49135125	1/4" E 6.3	10	Standard	4009311351259	5
49135130	1/4" E 6.3	11	Standard	4009311351309	5
49135135	1/4" E 6.3	12	Standard	4009311351359	5
49135140	1/4" E 6.3	13	Standard	4009311351409	5



SET DI CHIAVI A BUSSOLA CON ADATTATORE 1/4" - 5PZ.

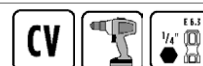

Art.	Gambo	Diametro (mm)	Qualità	EAN	📦
49135100	1/4" E 6.3	7/8/10/13	Standard	4009311351009	5



ADATTATORE PER CHIAVE A BUSSOLA, GAMBO 1/4" CON FUNZIONE A IMPULSI



- Zona di torsione singola
- Per avvitatura a impulsi
- Molto resistenti



Art.	Gambo	Uscita	Lunghezza (mm)	EAN	📦
49134220	1/4" E 6.3	1/4"	65		5
49134225	1/4" E 6.3	3/8"	65		5
49134230	1/4" E 6.3	1/2"	72		5
49134200	1/4" E 6.3	1/4"	150		5
49134205	1/4" E 6.3	3/8"	150		5
49134210	1/4" E 6.3	1/2"	150		5

SET DI ADATTATORI PER CHIAVE A BUSSOLA, GAMBO 1/4" CON FUNZIONE A IMPULSI - 3PZ.



- Zona di torsione singola
- Per avvitatura a impulsi
- Molto resistenti



Art.	Gambo	Uscita	Lunghezza (mm)	EAN	📦
49134215	1/4" E 6.3	1/4", 3/8", 1/2"	65-72		5

SET DI ADATTATORI PER CHIAVE A BUSSOLA, GAMBO 1/4" - 2 O 3PZ.

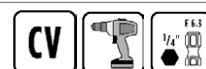

Art.	Gambo	Uscita	Lunghezza (mm)	EAN	📦
49134100	1/4" E 6.3	1/4", 3/8", 1/2"	65-72		5
49134105	1/4" E 6.3	3/8", 1/2"	65-72		5

SET

SET DI BITS CR-V FORMATO TASCABILE CON MOSCHETTONE

- Bits con impronta: PH1, PH2, PZ1, PZ2, T15, T20, T25, T30, HEX4, HEX5
- Versione in blister appendibile o in display da banco



Art.	Tipo	Lunghezza (mm)	N°pezzi	EAN	📦
49118623	PH, PZ, TORX, HEX	50	10		10
49118624	PH, PZ, TORX, HEX	50	10		50

SET DI BITS CR-V FORMATO TASCABILE

- Bits con impronta: PH1, PH2, PZ1, PZ2, T15, T20, T25, T30, HEX4, HEX5
- Versione da 50mm o 25mm con portabit (11 pezzi)



Art.	Tipo	Lunghezza (mm)	N°pezzi	EAN	
49118643	PH, PZ, TORX, HEX	50	10		12
49118663	PH, PZ, TORX, HEX	25	11		12

SET DI BITS IMPACT FORMATO TASCABILE CON MOSCHETTONE

- Bits con impronta: PH1, PH2, PZ1, PZ2, T15, T20, T25, T30, HEX4, HEX5
- Versione in blister appendibile o in display da banco



Art.	Tipo	Lunghezza (mm)	N°pezzi	EAN	
49118633	PH, PZ, TORX, HEX	50	10		10
49118634	PH, PZ, TORX, HEX	50	10		50

SET DI BITS IMPACT FORMATO TASCABILE

- Bits con impronta: PH1, PH2, PZ1, PZ2, T15, T20, T25, T30, HEX4, HEX5
- Versione da 50mm o 25mm con portabit (11 pezzi)



Art.	Tipo	Lunghezza (mm)	N°pezzi	EAN	
49118653	PH, PZ, TORX, HEX	50	10		12
49118673	PH, PZ, TORX, HEX	25	11		12

MINI-CASE DI BITS CR-V 25 PEZZI



Art.	Tipo	Lunghezza (mm)	N°pezzi	EAN	
49119004	TORX 20	25	25		32
49119014	TORX 25	25	25		32
49119024	PH2	25	25		32
49119034	PZ2	25	25		32

EINHELL SET DI BITS E CHIAVI A BUSSOLA IMPACT - 39PZ.



- Set completo
- Adatto all'avvitatura ad impulsu

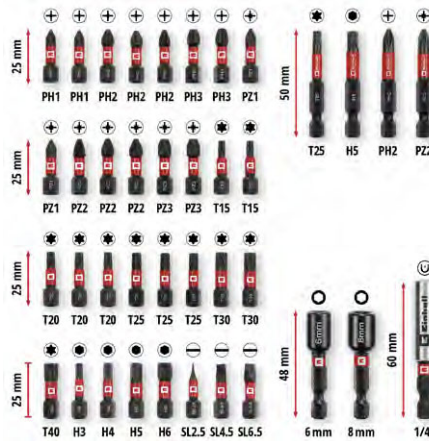

Art.	Tipo	Lunghezza (mm)	N°pezzi	EAN	
49109210	Slot, PH, PZ, TORX, HEX	25, 50	39		1

EINHELL SET DI BITS E CHIAVI A BUSSOLA IMPACT - 39PZ.



- Set completo
- Adatto all'avvitatura ad impulsu

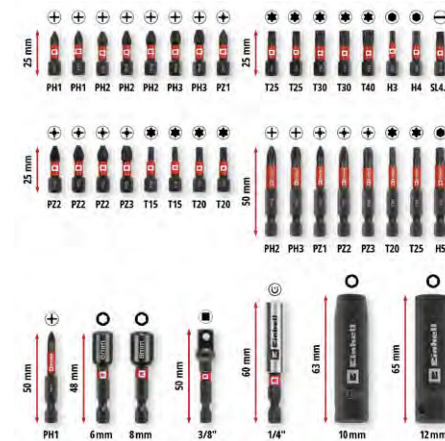

Art.	Tipo	Lunghezza (mm)	N°pezzi	EAN	
49109220	Slot, PH, PZ, TORX, HEX	25, 50	39		1

EINHELL SET DI BITS E CHIAVI A BUSSOLA IMPACT - 35PZ.



- Set completo
- Adatto all'avvitatura ad impulsu

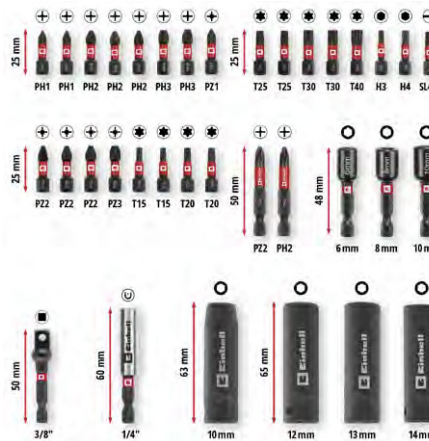

Art.	Tipo	Lunghezza (mm)	N°pezzi	EAN	
49109230	Slot, PH, PZ, TORX, HEX	25	35		1

EINHELL SET DI BITS E CHIAVI A BUSSOLA IMPACT - 38PZ.



- Set completo
- Adatto all'avvitatura ad impulsi

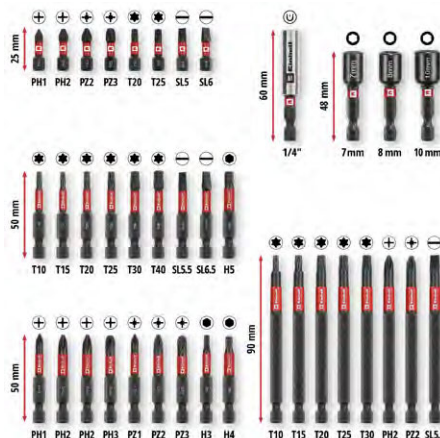

Art.	Tipo	Lunghezza (mm)	N°pezzi	EAN	
49109250	Slot, PH, PZ, TORX, HEX	25, 50, 90	38		1

EINHELL SET DI BITS CON CHIAVI A BUSSOLA E CRICCHETTO - 37PZ.



- Acciaio Cromo-Vanadio
- Valigetta per protezione inserti
- Adattatore Quick-Change

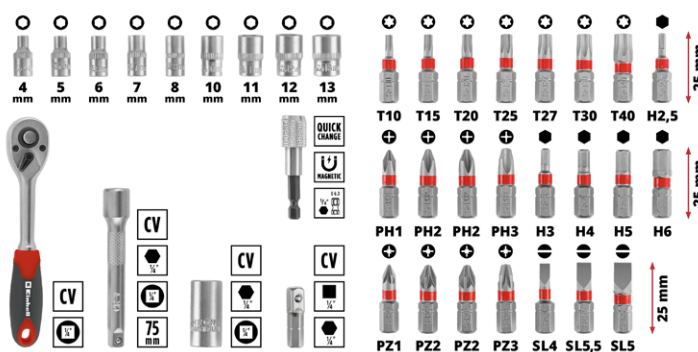

Art.	Tipo	Lunghezza (mm)	N°pezzi	EAN	
49109022	Slot, PH, PZ, HEX, TORX, Bussola	25	37		1

EINHELL SET DI BITS 25MM E 50MM E ADATTATORE QUICK-CHANGE MAGNETICO - 42PZ.

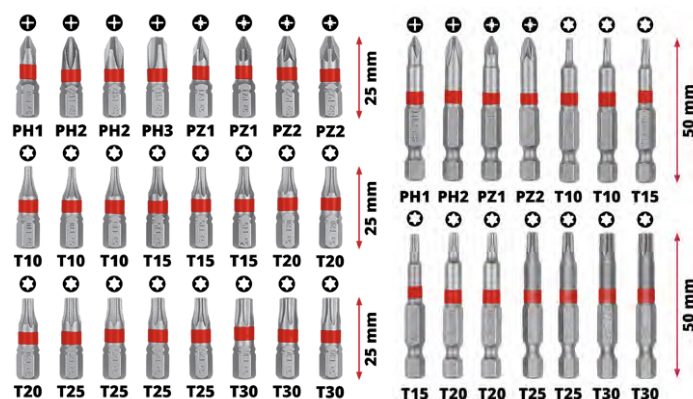

Art.	Tipo	Lunghezza (mm)	N°pezzi	EAN	
49118953	PH, PZ, TORX, HEX	25, 50	42		1

BITS E ACCESSORI PER AVVITATURA

EINHELL SET DI BITS 90MM - 16PZ.

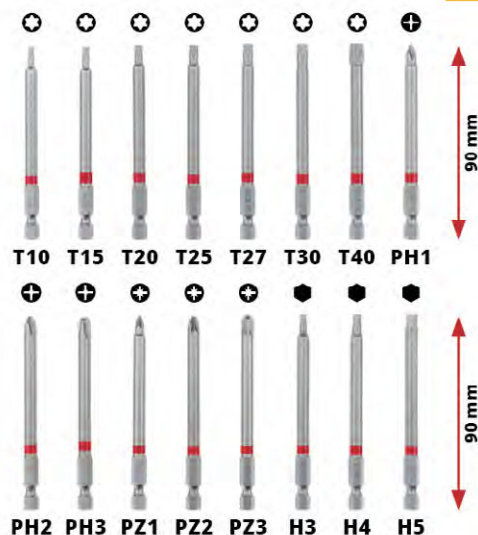

Art.	Tipo	Lunghezza (mm)	N°pezzi	EAN	
49118973	PH, PZ, TORX, HEX	90	16		1

EINHELL SET DI BITS ASSORTITI CON ADATTATORE QUICK-CHANGE - 32PZ.



▪ Set completo con portabit e adattatore

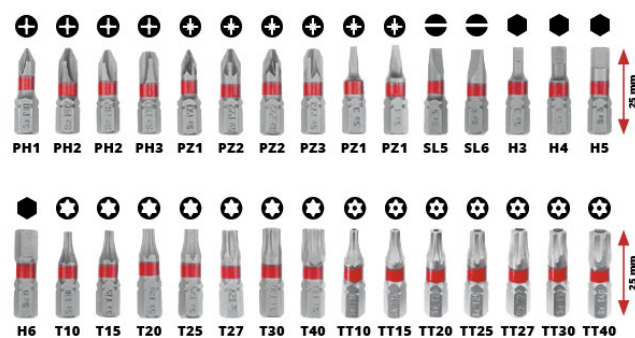

Art.	Tipo	Lunghezza (mm)	N°pezzi	EAN	
49118693	Slot, PH, PZ, HEX, TORX, T-TORX	25	32		5

SET DI BITS 25 E 50MM CON PORTABIT IN DISPENSER - 9PZ.



EXPERT



Art.	Tipo	Lunghezza (mm)	N°pezzi	EAN	
49113803	PH, PZ, Slot	25-50	9		10

SET DI BITS ASSORTITI IN ACCIAIO CR-V CON CLIP PER CINTURA IN DISPLAY - 32PZ



CLASSIC

- Acciaio Cromo-Vanadio
- Scatola espositiva
- Adattatore rapido

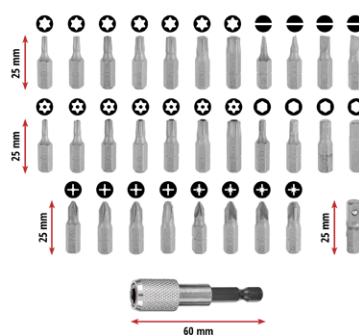

Art.	Tipo	Lunghezza (mm)	N°pezzi	EAN	
49118490	PH, PZ, TORX, HEX	25	32		15
49118496	PH, PZ, TORX, HEX	25	32		16

BOX DI BITS E CHIAVI A BUSSOLA CON CRICCHETTO - 20PZ.

CLASSIC

- Acciaio CV
- Manico in acciaio inox
- Clip per cintura



Art.	Tipo	Lunghezza (mm)	N°pezzi	EAN	
49118584	PH-PZ-HEX-TORX-SLOT	25	20		5



BITS DI AVVITATURA IN ACCIAIO INDUSTRIALE S2 TIC-TAC CON ADATTATORI E PORTABIT ESTENSIBILE - 23PZ.

CLASSIC



Art.	Tipo	Lunghezza (mm)	N°pezzi	EAN	
49120090	PH-PZ-TORX	25, 50	23		1



SET DI PUNTE PER RIPARAZIONE SMARTPHONE IN DISPLAY - 17PZ.

CLASSIC

- Ampio assortimento di punte per MacBook, Iphone, altri smartphones, occhiali e videocamere



Art.	Tipo	Lunghezza (mm)	N°pezzi	EAN	
49119490	PH-SLOT-TORX-T-TORX-TRIHING-PENTALOBE	25	17		14



CHIAVI A BUSSOLA PER AUTO



SET DI CHIAVI A BUSSOLA PER PNEUMATICI AUTO - 3PZ.



EXPERT

- Acciaio CrMo
- resistente alla torsione
- Rivestimento protettivo antigraffio
- Per avvitatori a impulsivi



Art.	Attacco	Misure	Lung. totale	EAN	📦
49109263	1/2"	17/19/21mm	80mm		1

SET DI CHIAVI A BUSSOLA PER PNEUMATICI AUTO - 3PZ.



EXPERT

- Acciaio CrMo
- resistente alla torsione
- Rivestimento protettivo antigraffio
- Per avvitatori a impulsivi



Art.	Attacco	Misure	Lung. totale	EAN	📦
49109273	1/2"	17/19/21mm	80mm		1

SET DI CHIAVI A BUSSOLA DA IMPATTO CON ADATTATORE QUADRO 1/2" - 12PZ.



EXPERT

- Acciaio CrMo
- resistente alla torsione
- Per avvitatori a impulsivi



Art.	Attacco	Misure	Lung. totale	EAN	
49109283	1/2"	10-21mm	40mm		1

SET DI CHIAVI A BUSSOLA E BITS DA IMPATTO CON ADATTATORE ESAGONALE 1/4" E QUADRO 1/2" - 32PZ.



EXPERT

- Acciaio CrMo
- resistente alla torsione
- Per avvitatori a impulsivi
- Bits HEX-TORX-XZN



Art.	Attacco	Misure	Lung. totale	EAN	
49109288	1/4"- 1/2"	10-22mm	30-80mm		1



Acciaio CrMo fosfato al manganese per un'elevata resistenza alla torsione





SET PER FORARE E AVVITARE



EINHELL SET DI PUNTE PER MURO, METALLO E LEGNO CON BITS E CHIAVI A BUSSOLA - 40PZ.



EXPERT

- Acciaio Cromo-Vanadio
- Valigetta per protezione inserti

Punte per edilizia, metallo e legno assortite 3-8mm
 Bits assortiti PH, PZ, TORX, HEX, SLOT
 Svasatore per legno WS
 Chiavi a bussola 5-13mm

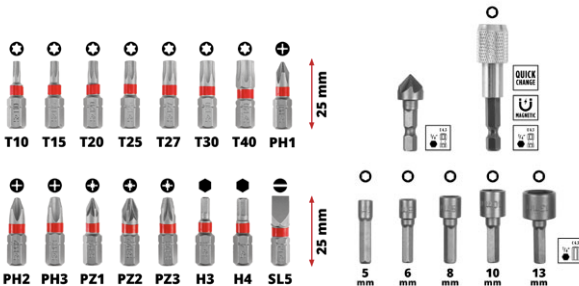

Art.	Tipo punte	Lunghezza (mm)	N°pezzi	EAN	
49109053	Slot, PH, PZ, HEX, TORX	25	40		1

EINHELL SET DI BITS E CHIAVI A BUSSOLA IMPACT, PUNTE PER MURO, METALLO E LEGNO CON SVASATORE E PORTABIT QUICK-CHANGE - 39PZ.

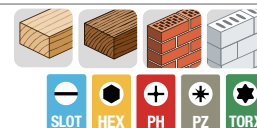

EXPERT

- Set completo per foratura e avvitatura
- Punta per edilizia, metallo e legno
- Bits e bussole adatti all'avvitatura ad impulsi
- Punta con attacco esagonale
- Portabit impact
- Svasatore per legno

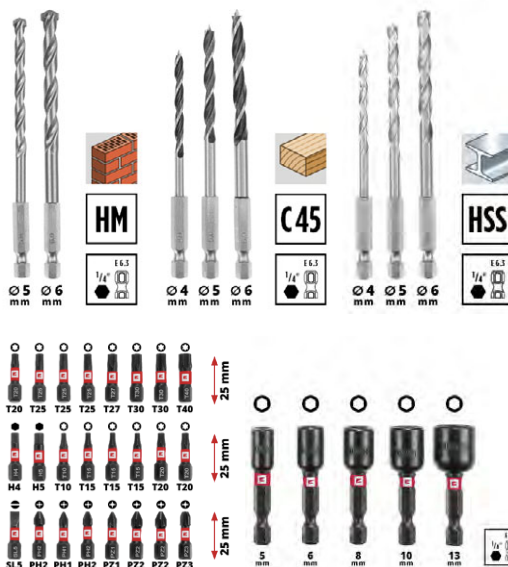

Art.	Tipo punta	Lunghezza (mm)	N°pezzi	EAN	
49108759	Slot, PH, PZ, TORX, HEX	25	39		1

SET DI PUNTE UNIVERSALI, BITS E CHIAVI A BUSSOLA IMPACT - 39PZ.

Set completo per foratura e avvitatura ad impulsi
Con portabit
Punte a codolo esagonale

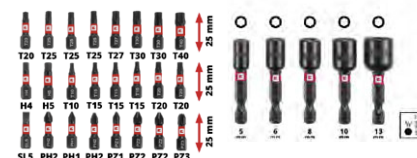

Art.	N°pezzi	EAN	
49108763	39		1

EINHELL SET DI PUNTE A CODOLO ESAGONALE MISTE PER LEGNO, METALLO ED EDILIZIA - 16PZ.



EXPERT

- 5 punte per metallo
- 5 punte per legno
- 6 punte per edilizia



Art.	Materiale punta	Ø	N°pezzi	EAN	
49108953	HSS/HM/CV	3-8mm	16		1

SET PER FORARE E AVVITARE

SET DI PUNTE PER MURO E BITS ASSORTITI - 33PZ.

CLASSIC

- Set completo
- In valigetta resistente



Art.	Tipo punte	Lunghezza (mm)	N°pezzi	EAN	📦
49108940	SLOT, PH, PZ, TORX, HEX	3-12mm	33	4009311089403	1

SET DI PUNTE PER TRAPANO E BITS IN POWERBOX

CLASSIC

- Ampio assortimento di punte per metallo, legno e edilizia
- Ampio assortimento di bits PH, PZ, Torx e piatte
- Adattatori e boccole inclusi



Art.	Materiale	Tipo punte	N°pezzi	EAN	📦
49109104	Edilizia, Metallo e Legno	PH-PZ-TORX-SLOT-HEX	41	4009311091043	1
49109106			62	4009311091062	1
49109110			101	4009311091103	1

SET DI PUNTE MISTE PER LEGNO, METALLO ED EDILIZIA - 15PZ.

CLASSIC

- 5 Punte per edilizia
- 5 punte per metallo
- 5 punte per legno



Art.	Tipo punte	Ø	N°pezzi	EAN	📦
49109157	HSS/HM/CV	4-10mm	15	4009311091572	1

SET DI PUNTE MISTE PER LEGNO, METALLO ED EDILIZIA - 9PZ.

CLASSIC

- Set completo
- Rapporto qualità-prezzo
- Scatoletta espositiva a ventaglio



Art.	Tipo punte	Ø	N°pezzi	EAN	📦
49109154	HSS/HM/CV	4, 6, 8mm	9	4009311091542	8

DISCHI DIAMANTATI



QUALE SCEGLIERE?

Corona continua:

per tagli netti e regolari richiesti per ceramiche, piastrelle, gres e altri materiali delicati. Più lenta rispetto alle altre corone.



Corona continua scanalata "turbo":

per un taglio abbastanza pulito. potrebbe provocare qualche scheggiatura su materiali delicati.

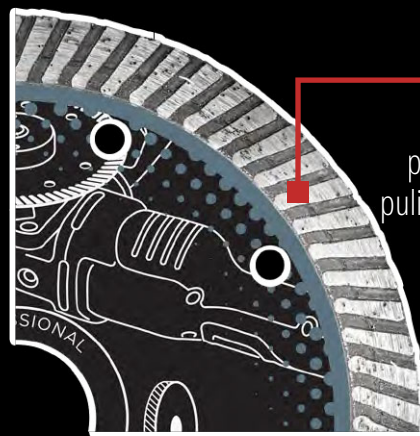

Corona segmentata:

lo spazio tra un settore e l'altro permette al materiale tagliato di fuoriuscire più rapidamente, per un taglio molto veloce. Non indicato per materiali delicati.



Corona multimateriale:

i fori posti sotto il segmento forniscono un raffreddamento ottimale, appositamente sviluppato per tagliare più materiali in una volta sola, rendendolo molto versatile.

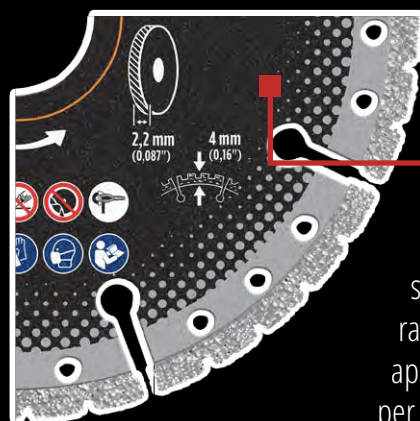

DISCHI DIAMANTATI A CORONA CONTINUA

DISCO DIAMANTATO TURBO EXTRAFINO "SPIDER" PER GRES PORCELLANATO

PROFESSIONAL

- Taglio pulito
- Taglio a secco o umido
- Lunga durata

Per gres porcellanato, marmo e ceramica
Alloggio da 22,23mm

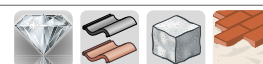

Art.	Ø	Altezza segmento	Spessore	EAN	
49727140	115mm	10mm	1,4mm	4009317271402	2
49727540	125mm	10mm	1,4mm	4009317275404	2

DISCO DIAMANTATO PER ACCIAIO INOX E METALLO

PROFESSIONAL

- Taglio pulito
- Nessuna riduzione del diametro
- Lunga durata

per acciaio inox, lameiere e tubi metallici
Adatto all'uso continuo
Alloggio da 22,23mm



Art.	Ø	Altezza segmento	Spessore	EAN	
49720140	115mm	3mm	1,0mm	4009317201402	2
49720540	125mm	3mm	1,0mm	4009317205404	2

DISCO DIAMANTATO PER TAGLIO E RETTIFICA

PROFESSIONAL

- Taglio extra rifinito
- Taglio a secco o ad acqua
- Adatto per il Taglio obliquo

Per gres, ceramica e pietra naturale
la superficie tagliata viene anche rettificata grazie al segmento esteso a nido d'ape

Alloggio da 22,23mm



Art.	Ø	Altezza segmento	Spessore	EAN	
49796140	115mm	25mm	1,6mm	40093172961402	2



DISCO DIAMANTATO TURBO PER GRES PORCELLANATO

EXPERT

Per ceramica, piastrelle,
travertino, marmo e gres
Alloggio da 22,23mm



Art.	Ø	Altezza segmento	Spessore	EAN	📦
49795940	110mm	7,0mm	2,0mm	4009317252405	5
49725140	115mm	5,0mm	1,8mm	40093172521405	5
49725240	125mm	5,0mm	1,9mm	40093172522405	5
49725840	230mm	7,0mm	2,6mm	40093172528405	2

DISCO DIAMANTATO A FILO CONTINUO PER PIASTRELLE E CERAMICA

CLASSIC

- Saldato laser
- Taglio a secco o ad acqua

Per ceramica, piastrelle,
terracotta, tegole e pietra naturale
Alloggio da 22,23mm



Art.	Ø	Altezza segmento	Spessore	EAN	📦
49725170	115mm	5,0mm	1,9mm	40093172521705	5
49725270	125mm	5,0mm	2,0mm	40093172522705	5
49725870	230mm	5,0mm	2,4mm	40093172528705	2

DISCHI DIAMANTATI A CORONA CONTINUA SCANALATA

DISCO DIAMANTATO TURBO PER MATERIALI EDILI

PROFESSIONAL

- Taglio pulito
- Taglio a secco o umido
- Lunga durata

Per cemento, mattoni,
calcestruzzo armato, porfido
Alloggio da 22,23mm



Art.	Ø	Altezza segmento	Spessore	EAN	📦
49722140	115mm	12mm	2,2mm	4009317221401	2
49722540	125mm	12mm	2,2mm	4009317225401	2

DISCO DIAMANTATO TURBO PER GRES PORCELLANATO

EXPERT

- Taglio pulito
- Ottimo per il gres
- Taglio a secco o ad acqua

Per gres porcellanato,
ceramica e terracotta
Alloggio da 22,23mm



Art.	Ø	Altezza segmento	Spessore	EAN	📦
49721140	115mm	7,0mm	1,4mm	4009317211402	2
49724540	125mm	7,0mm	1,4mm	4009317245407	2
49721840	230mm	7,0mm	2,2mm	4009317218401	1

DISCO DIAMANTATO TURBO PER CEMENTO E MATTONI

EXPERT

- Segmento sinterizzato
- Rapido e preciso

Per cemento, mattoni, tegole, ceramica e pietra naturale
Alloggio da 22,23mm



Art.	Ø	Altezza segmento	Spessore	EAN	📦
49797140	115mm	10mm	2,2mm	4009317971403	2
49797540	125mm	10mm	2,2mm	4009317975403	5
49797840	230mm	10mm	2,8mm	4009317978404	1

DISCO DIAMANTATO TURBO PER CERAMICA E GRES PORCELLANATO

CLASSIC

- Taglio fine e pulito
- Taglio a secco o ad acqua

Per ceramica e gres porcellanato piastrelle, tegole e pietra naturale
Alloggio da 22,23mm



Art.	Ø	Altezza segmento	Spessore	EAN	📦
49727170	115mm	8,0mm	1,4mm	4009317271702	2
49727570	125mm	8,0mm	1,4mm	4009317275702	2
49727870	230mm	8,0mm	2,0mm	4009317278702	2

DISCO DIAMANTATO TURBO CEMENTO E MATTONI

CLASSIC

- Segmento saldato laser
- Taglio a secco o ad acqua

Per cemento, mattoni tegole e materiale da costruzione
Alloggio da 22,23mm



Art.	Ø	Altezza segmento	Spessore	EAN	📦
49797170	115mm	7,0mm	2,2mm	4009317971702	5
49797570	125mm	7,0mm	2,2mm	4009317975702	5
49797870	230mm	7,0mm	2,8mm	4009317978704	1

DISCHI DIAMANTATI A CORONA SEGMENTATA

DISCO DIAMANTATO SEGMENTATO PER MATERIALI EDILI DURI

PROFESSIONAL

- Taglio pulito
- Lunga durata

Per calcestruzzo, calcestruzzo armato, clinker, pietra naturale, granito
Alloggio da 22,23mm



Art.	Ø	Altezza segmento	Spessore	EAN	📦
49723140	115mm	12mm	2,2mm	4009317231400	1
49723540	125mm	12mm	2,2mm	4009317235400	1

DISCO DIAMANTATO SEGMENTATO PER EDILIZIA

EXPERT

- Segmento sinterizzato
- Taglio veloce
- Taglio a secco o ad acqua

Per cemento, mattoni, terracotta, piastrelle e materiale da costruzione
Alloggio da 22,23mm



Art.	Ø	Altezza segmento	Spessore	EAN	📦
49798140	115mm	10mm	2,0mm	4009317981402	5
49798540	125mm	10mm	2,0mm	4009317985402	5
49798740	180mm	10mm	2,4mm	4009317987402	1
49798840	230mm	10mm	2,6mm	4009317988402	1

DISCO DIAMANTATO SEGMENTATO PER CEMENTO E CALCESTRUZZO

CLASSIC

- Segmento saldato laser
- Taglio a secco o ad acqua
- Taglio veloce

Per cemento, calcestruzzo, mattoni e marmo
Alloggio da 22,23mm



Art.	Ø	Altezza segmento	Spessore	EAN	📦
49796170	115mm	7,0mm	1,9mm	4009317961702	5
49796570	125mm	7,0mm	1,9mm	4009317965702	5
49796870	230mm	7,0mm	2,5mm	4009317968702	1

DISCHI MULTIMATERIALE

DISCO DIAMANTATO MULTIMATERIALE

PROFESSIONAL

- Taglio pulito
- Versatile e polivalente
- Ventilazione ottimizzata
- Lunga durata

Per materiali edili, legno con chiodi, metallo, cartongesso, PVC, lamiera e muratura
Alloggio da 22,23mm



Art.	Ø	Altezza segmento	Spessore	EAN	📦
49789140	115mm	4mm	2,2mm	4009317891402	1
49789540	125mm	4mm	2,2mm	4009317895402	1

DISCO AL CARBURO DI TUNGSTENO MULTIMATERIALE EASY CUT PER MINI-SMERIGLIATRICE 76MM

EXPERT

- Taglio pulito
- Sicuro e veloce

Per legno duro e tenero, legno con chiodi, PVC e plastica
Alloggio da 10,0mm



Art.	Ø	Altezza segmento	Spessore	EAN	📦
49790240	76mm	1,4mm	1,0mm	4009317902402	10

DISCHI E MOLE DIAMANTATE

DISCO AL CARBURO DI TUNGSTENO MULTIMATERIALE EASY CUT



EXPERT

- Taglio pulito
- Sicuro e veloce

*Per legno duro e tenero,
legno con chiodi, PVC e plastica
Alloggio da 22,23mm*



Art.	Ø	Altezza segmento	Spessore	EAN	📦
49790140	115mm	1,4mm	1,0mm	4009317901402	2
49790540	125mm	1,4mm	1,0mm	4009317905402	2

SET

SET DI DISCHI DIAMANTATI ASSORTITI DA 115MM



Art.	Ø	N° pezzi	EAN	📦
49797060	115mm	2	4009317970602	1
49797095	115mm	3	4009317970952	5

SET DI 3 DISCHI DIAMANTATI ASSORTITI

CLASSIC

- Set completo
- Segmentato, turbo, filo continuo

*Per tutti i tipi di materiale
Alloggio da 22,23mm*



Art.	Ø	N° pezzi	EAN	📦
49797080	115mm	3	4009317970802	1

SET DI DISCHI DIAMANTATI SEGMENTATO E TURBO - 2PZ.

CLASSIC

*Per mattoni, cemento, pietra,
ceramica e gres porcellanato
Alloggio da 22,23mm*

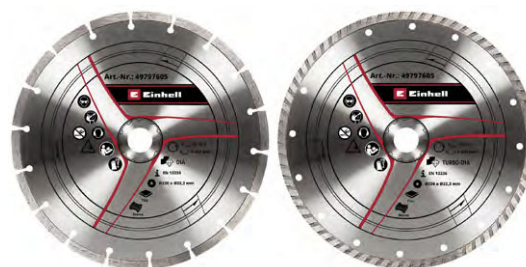

Art.	Ø	N° pezzi	EAN	📦
49797605	230mm	2	4009317976052	1



DISCHI DIAMANTATI PER TAGLIAPIETRE E TAGLIAPIASTRELLE



DISCO DIAMANTATO A FILO CONTINUO PER TAGLIAPIASTRELLE

EXPERT

- Saldato laser
- Taglio a secco o ad acqua

*Per ceramica,
piastrelle, marmo
Alloggio da 25,4mm*



Art.	Ø	Altezza segmento	Spessore	EAN	📦
49725750	180mm	7,0mm	2,2mm	4009517955550	2
49795850	180mm	6,0mm	2,4mm	4009517955550	1
49795855	200mm	6,0mm	2,4mm	4009517955550	1



DISCO DIAMANTATO TURBO PER TAGLIAPIASTRELLE

EXPERT

- Saldato laser
- Taglio a secco o ad acqua

Per ceramica, piastrelle, marmo
Alloggio da 25,4mm



Art.	Ø	Altezza segmento	Spessore	EAN	📦
49797650	180mm	8,0mm	2,5mm	4009319979509	1

DISCO DIAMANTATO TURBO PER TAGLIAPIETRE

EXPERT

- Saldato laser
- Taglio a secco o ad acqua

Per pietra naturale
Alloggio da 25,4mm



Art.	Ø	Altezza segmento	Spessore	EAN	📦
49797851	250mm	8,0mm	2,5mm	4009319979510	1
49797950	300mm	8,0mm	3,6mm	4009319979509	1



MOLE DIAMANTATE





MOLA DIAMANTATA DOPPIA FILA

PROFESSIONAL

- Saldato a laser
- Lavorazioni di rettifica
- Pulizia profonda

*Per calcestruzzo, marmo,
granito e pietra
Alloggio da 22,23mm*



Art.	Ø	Altezza segmento	Spessore	EAN	
49726210	115mm	5mm	8mm		1



MOLA DIAMANTATA FILA SINGOLA

PROFESSIONAL

- Saldato a laser
- Lavorazioni di rettifica
- Pulizia profonda

*Per calcestruzzo, marmo,
granito e pietra
Alloggio da 22,23mm*



Art.	Ø	Altezza segmento	Spessore	EAN	
49726855	180mm	6mm	8mm		1

MOLA DIAMANTATA CORONA SCANALATA TURBO

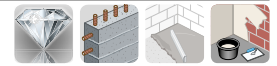

EXPERT

- Saldato a laser
- Lavorazioni di rettifica
- Pulizia profonda

Per calcestruzzo, marmo, granito e pietra
Alloggio da 22,23mm



Art.	Ø	Altezza segmento	Spessore	EAN	
49726410	125mm	5mm	3mm	4009317264101	1

MOLA IN METALLO DURO



EXPERT

- Grana 10-14
- Per lavori di rettifica, rimozione o livellamento

Per colla da piastrelle, Residui di colla e vetroresina
Cemento, calcestruzzo, vernice e intonaco
Alloggio da 22,23mm



Art.	Ø	Altezza segmento	Spessore	EAN	
49726110	115mm	20mm	2,9mm	4009317261100	1

MOLA PER SGROSSATURA LEGNO



EXPERT

- Finitura con denti in acciaio al carbonio
- Non usare su chiodi

Alloggio da 22,23mm



Art.	Ø	N°denti	EAN	
49726010	115mm	600	4009317260101	2
49726020	125mm	750	4009317260202	2

DISCHI ABRASIVI



QUALE SCEGLIERE? >>>

EXPERT:

Adatti per tutti gli acciai, consigliati per il taglio dell'acciaio Inox, ghisa e acciaio dolce.

Materiale abrasivo in Alumina-Zirconia, dal grande potere abrasivo e capacità di taglio.

Ideale per macchine ad alta potenza.

Durata fino al 20% più lunga rispetto alla linea Classic.

Certificati OSA.



CLASSIC:

Per il taglio di ferro e acciaio. Non consigliato per il taglio dell'acciaio inox.

Materiale Abrasivo in Ossido di Alluminio

Taglio preciso e pulito.

Ottimo rapporto qualità-prezzo.

PER METALLO

DISCO DA TAGLIO PER ACCIAIO INOX E METALLO

EXPERT

- Materiale abrasivo di alta qualità
- Esente da Ferro, Zolfo e Cloro
- Lunga durata
- Alta capacità di asportazione

*Per acciaio inox e profili metallici, lamiere e tubi d'acciaio
Alloggio da 22,23mm
Certificato OSA*



Art.	Ø	Spessore	Forma Disco	EAN	📦
49711711	115mm	1,0mm		4009317917111	25
49711716	115mm	1,6mm		4009317917116	25
49711712	125mm	1,0mm		4009317917112	25
49711717	125mm	1,6mm		4009317917117	25
49711733	230mm	2,0mm		4009317917133	25

DISCO DA TAGLIO PER METALLO

EXPERT

- Materiale abrasivo di alta qualità
- Esente da Ferro, Zolfo e Cloro
- Lunga durata
- Alta capacità di asportazione

*Per acciaio, rame, ghisa e metalli ferrosi.
Alloggio da 22,23mm
Certificato OSA*



Art.	Ø	Spessore	Forma Disco	EAN	📦
49791150	115mm	3,0mm		4009317919150	25
49791250	125mm	3,0mm		4009317919125	25
49791970	230mm	3,0mm		4009317919170	5
49791950	230mm	3,0mm		4009317919150	25

DISCO DA SBAVO PER METALLO SPESSORE 6,0MM

EXPERT

- Materiale abrasivo di alta qualità
- Esente da Ferro, Zolfo e Cloro
- Lunga durata
- Alta capacità di asportazione

*Per saldature, metallo, acciaio e ghisa
Certificato OSA
Alloggio da 22,23mm*



Art.	Ø	Spessore	Forma Disco	EAN	📦
49793165	115mm	6,0mm		4009317921165	10
49793265	125mm	6,0mm		4009317921265	10
49793965	230mm	6,0mm		4009317921965	10

DISCHI DA TAGLIO PER METALLO

CENTRO DEPRESSO

CLASSIC

- Materiale abrasivo di alta qualità
- Esente da Ferro, Zolfo e Cloro
- Taglio pulito e preciso

*Per profili, laminati e tubi metallici
Alloggio da 22,23mm*



Art.	Ø	Spessore	Forma Disco	EAN	📦
49791961	230mm	3,0mm		4009317919612	25

DISCO DA TAGLIO PER METALLO

CLASSIC

- Materiale abrasivo di alta qualità
- Esente da Ferro, Zolfo e Cloro
- Taglio pulito e preciso

Per profili, laminati e tubi metallici
Alloggio da 22,23mm



Art.	Ø	Spessore	Forma Disco	EAN	📦
49711811	115mm	1,0mm		4009317118112	50
49711816	115mm	1,6mm		4009317118169	50
49711812	125mm	1,0mm		4009317118121	50
49711817	125mm	1,6mm		4009317118176	50
49711828	180mm	1,6mm		4009317118282	25
49711833	230mm	2,0mm		4009317118338	25

PER PIETRA E MATTONI

DISCO DA TAGLIO PER MATTONI SPESSORE 3,0MM

EXPERT

- Materiale abrasivo in carburo di silicio
- Esente da Ferro, Zolfo e Cloro
- Lunga durata
- Alta capacità di asportazione

Per mattoni
Alloggio da 22,23mm



Art.	Ø	Spessore	Forma Disco	EAN	📦
49792150	115mm	3,0mm		4009317921509	25
49792250	125mm	3,0mm		4009317922506	25
49792950	230mm	3,0mm		4009317929505	25

MULTIMATERIALE

DISCO DA TAGLIO MULTIMATERIALE

EXPERT

- Versatile e pratico
- Materiale abrasivo in carburo di silicio
- Esente da Ferro, Zolfo e Cloro
- Lunga durata
- Alta capacità di asportazione

Per acciaio Inox, profili metallici, alluminio e mattoni.
Alloggio da 22,23mm
Certificato OSA



Art.	Ø	Spessore	Forma Disco	EAN	📦
49711611	115mm	1,0mm		4009317116110	25
49711616	115mm	1,6mm		4009317116165	25
49711612	125mm	1,0mm		4009317116129	25
49711617	125mm	1,6mm		4009317116172	25

DISCO PER DECAPPAGGIO

PROFESSIONAL

- Larghezza utile 13 mm
- Utilizzo frontale, diagonale o laterale

Per metallo, acciaio Inox, pittura, vernice, plastica, legno, etc..



Art.	Ø	Grana	Giri max./min.	EAN	📦
49479211	115mm	22,23mm	11.000	4009314792119	5
49479311	125mm	22,23mm	9.800	4009314793116	5

SET

DISCO DA TAGLIO PER METALLO PER MINI SMERIGLIATRICE 76MM - 5PZ.

EXPERT

- Taglio pulito
- Sicuro e veloce

Per metallo e lamiera
Alloggio da 10,0mm



Art.	Ø	Spessore	Forma Disco	EAN	
49711520	76mm	1,0mm			10

EINHELL SET DI DISCHI DA TAGLIO PER METALLO E ACCIAIO INOX - 5PZ.

EXPERT

- Materiale abrasivo di alta qualità
- Esente da Ferro, Zolfo e Cloro
- Lunga durata
- Alta capacità di asportazione

Per saldature, metallo,
acciaio e ghisa
Alloggio da 22,23mm



Art.	Ø	Spessore	Forma Disco	EAN	
49711521	115mm	1,0mm			20
49711522	125mm	1,0mm			20

SET DI DISCHI DIAMANTATI ASSORTITI DA 115MM



Art.	Ø	Spessore	N° pezzi	EAN	
49711525	115mm	1,0mm	10		5
49711442	125mm	1,0mm	10		10
49711526	115mm	1,0mm	50		1
49711527	115mm	1,0mm	100		1
49711722	125mm	1,0mm	10		20



DISCO DA TAGLIO PER METALLO - LATTINA DA 10 DISCHI

CLASSIC

- Materiale abrasivo di alta qualità
- Esente da Ferro, Zolfo e Cloro
- Taglio pulito e preciso

Per profili, laminati
e tubi metallici
Alloggio da 22,23mm



Art.	Ø	Spessore	Forma Disco	EAN	
49712021	115mm	1,0mm			1



SET DI DISCHI ABRASIVI PER PIETRA 3,0MM - 10PZ.

CLASSIC

- Materiale abrasivo di alta qualità
- Esente da Ferro, Zolfo e Cloro
- Taglio pulito e preciso

Per mattoni
Alloggio da 22,23mm



Art.	Ø	Spessore	Forma Disco	EAN	📦
49792195	115mm	3,0mm			20

DISCO PER TRONCATRICE PER METALLO

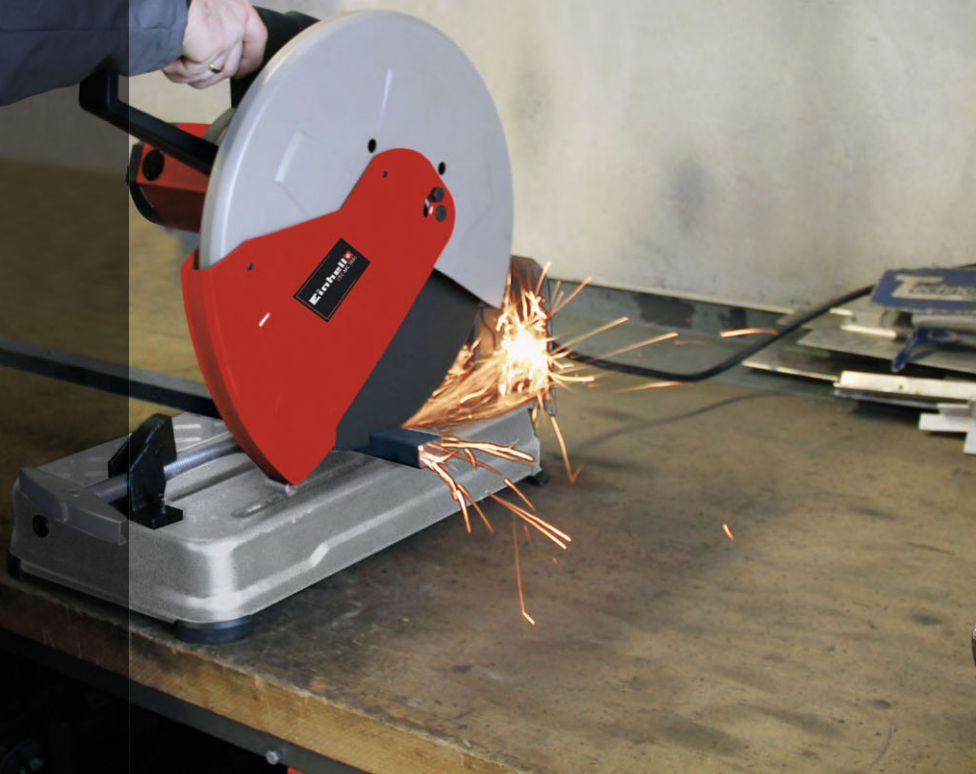

DISCO PER TRONCATRICE PER METALLO

CLASSIC

- Materiale abrasivo di alta qualità
- Esente da Ferro, Zolfo e Cloro
- Taglio pulito e preciso
- Nessuna riduzione di diametro

Alloggio da 25,4mm



Art.	Ø	Spessore	Forma Disco	EAN	📦
49791993	355 mm	2,8mm			10

DISCHI LAMELLARI ABRASIVI



QUALE SCEGLIERE? >>>

PROFESSIONAL:

- Abrasivo in corindone ceramico.
- Fino a 2x più duraturo del disco in zirconio.
- Utilizzo su acciaio e acciaio inox.
- Adatto all'utilizzo continuo.
- Platorello in fibra.
- Ø 115mm o 125mm.
- Grana 40, 60, 80, 100, 120.
- Certificati MPA.

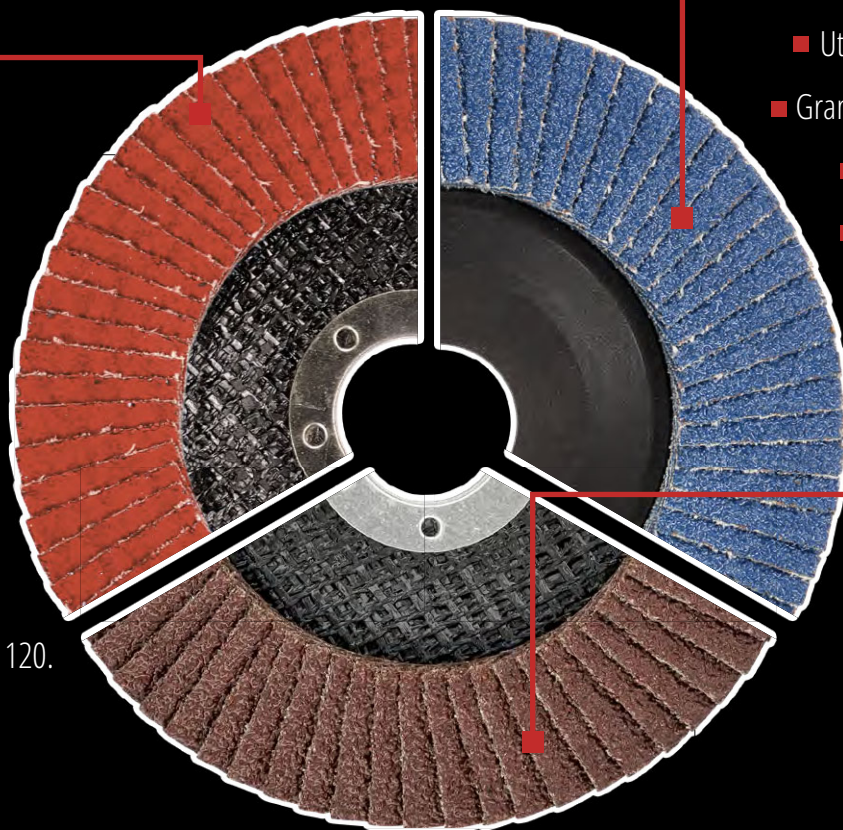

EXPERT:

- Abrasivo in zirconio.
- Utilizzo su acciaio e ferro.
- Grana 40, 60, 80, 100, 120.
- Platorello in plastica.
- Ø 115mm o 125mm.
- Certificati MPA.

CLASSIC:

- Abrasivo in ossido di alluminio.
- Utilizzo su legno, alluminio e metalli non-ferrosi.
- Platorello in fibra.
- Ø 115mm o 125mm.
- Grana 40, 60, 80, 100, 120.

DISCO LAMELLARE IN CORINDONE CERAMICO PER ACCIAIO INOX E METALLO



PROFESSIONAL

- Profilo conico
- Angolo di 12°
- Adatti all'utilizzo continuo
- Durata massima

Per acciaio inox,
metallo, ghisa,
lamiera e saldature
Certificati MPA
Alloggio da
22,23mm



Art.	Ø	Grana	Giri max./min.	EAN	📦
49795824	115mm	40	13.300	4 009 317 958 24 2	10
49795826	115mm	60	13.300	4 009 317 958 26 0	10
49795828	115mm	80	13.300	4 009 317 958 28 0	10
49795830	115mm	100	13.300	4 009 317 958 30 0	10
49795832	115mm	120	13.300	4 009 317 958 32 1	10
49795924	125mm	40	12.250	4 009 317 959 24 3	10
49795926	125mm	60	12.250	4 009 317 959 26 7	10
49795928	125mm	80	12.250	4 009 317 959 28 1	10
49795930	125mm	100	12.250	4 009 317 959 30 4	10
49795932	125mm	120	12.250	4 009 317 959 32 8	10

DISCO LAMELLARE IN ZIRCONIO PER INOX E METALLO



EXPERT

- Profilo conico
- Angolo di 12°
- Platorello rinforzato in plastica

Per acciaio inox, metallo,
ghisa, lamiera e saldature
Certificati MPA
Alloggio da 22,23mm



Art.	Ø	Grana	Giri max./min.	EAN	📦
49795634	115mm	40	13.300	4 009 317 956 34 1	10
49795636	115mm	60	13.300	4 009 317 956 36 3	10
49795638	115mm	80	13.300	4 009 317 956 38 9	10
49795640	115mm	100	13.300	4 009 317 956 40 0	10
49795642	115mm	120	13.300	4 009 317 956 42 6	10
49795644	125mm	40	12.250	4 009 317 956 44 0	10
49795646	125mm	60	12.250	4 009 317 956 46 2	10
49795648	125mm	80	12.250	4 009 317 956 48 8	10
49795650	125mm	100	12.250	4 009 317 956 50 1	10
49795652	125mm	120	12.250	4 009 317 956 52 5	10

DISCO LAMELLARE IN CORINDONE PER INOX E METALLO



CLASSIC

- Profilo conico
- Angolo di 12°
- Ideale per rimuovere la ruggine

*Per legno, alluminio, metalli non-ferrosi e plastica
Alloggio da 22,23mm*



Art.	Ø	Grana	Giri max./min.	EAN	📦
49794040	115mm	40	13.300	4 009 317 920 401	10
49794060	115mm	60	13.300	4 009 317 920 609	10
49794080	115mm	80	13.300	4 009 317 920 807	10
49794100	115mm	100	13.300	4 009 317 920 1002	10
49794120	115mm	120	13.300	4 009 317 920 1200	10
49795040	125mm	40	12.250	4 009 317 920 400	10
49795060	125mm	60	12.250	4 009 317 920 608	10
49795080	125mm	80	12.250	4 009 317 920 806	10
49795100	125mm	100	12.250	4 009 317 920 1001	10
49795120	125mm	120	12.250	4 009 317 920 1209	10



LAME PER SEGHETTO ALTERNATIVO



LAME PER LEGNO

LAME PER SEGHETTO PER LEGNO IN ACCIAIO AL CARBONIO HCS

EXPERT

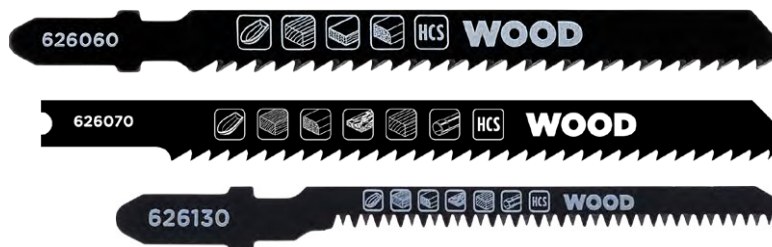

Per legni duri e legni teneri,
melamina, truciolato e plastica

Art.	Gambo	Lunghezza lama	N°pezzi	Tipo taglio	EAN	📦
49626060	T	76,5mm	2	Fine	4009316226060	5
49626065	T	76,5mm	5	Fine	4009316226065	5
49626070	U	81mm	2	Fine	4009316226070	5
49626075	T	76,5mm	2	Medio	4009316226075	5
49626080	T	76,5mm	5	Medio	4009316226080	5
49626085	U	82mm	2	Medio	4009316226085	5
49626090	T	76,5mm	2	Grossolano	4009316226090	5
49626095	T	76,5mm	5	Grossolano	4009316226095	5
49626100	U	82mm	2	Grossolano	4009316226100	5
49626105	T	71mm	2	Extra-Grossolano	4009316226105	5
49626110	T	71mm	5	Extra-Grossolano	4009316226110	5
49626130	T	58,5mm	2	Curvo	4009316226130	5
49626135	T	58,5mm	5	Curvo	4009316226135	5
49626165	T	76,5mm	2	Fine	4009316226165	5
49626250	T	121mm	2	Grossolano	4009316226250	5
49626255	T	91,5mm	2	Grossolano	4009316226255	5
49626270	T	128mm	2	Grossolano	4009316226270	5



LAME PER LAMINATO

LAMA PER SEGHETTO PER LAMINATO IN ACCIAIO AL CARBONIO HCS DENTATURA INVERTITA



PROFESSIONAL

Per laminati, parquet e PVC
Denti invertiti
Finitura di taglio extra fine



Art.	Gambo	Lunghezza lama	N°pezzi	Tipo taglio	EAN	📦
49626260		93,5mm	2	Inverso-Fine	40093162262603	5

LAMA PER SEGHETTO PER LAMINATO IN ACCIAIO AL CARBONIO HCS



PROFESSIONAL

Per tutti i tipi di legno,
laminati, parquet e PVC
Dentatura giapponese



Art.	Gambo	Lunghezza lama	N°pezzi	Tipo taglio	EAN	📦
49626265		76,5mm	2	Fine	40093162262658	5

LAME PER SEGHETTO PER LAMINATO IN ACCIAIO AL CARBONIO HCS DENTATURA INVERTITA



EXPERT

Per laminati, parquet e PVC
Denti invertiti
Finitura di taglio extra fine



Art.	Gambo	Lunghezza lama	N°pezzi	Tipo taglio	EAN	📦
49626145		76,5mm	2	Inverso-Fine	40093162261453	5
49626150		76,5mm	5	Inverso-Fine	40093162261507	5
49626155		73,5mm	2	Inverso-Fine	40093162261552	5

LAMA PER SEGHETTO PER LAMINATO IN LEGA BIMETALLICA HSS

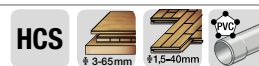

EXPERT

Per laminati, parquet e PVC
Denti dritti

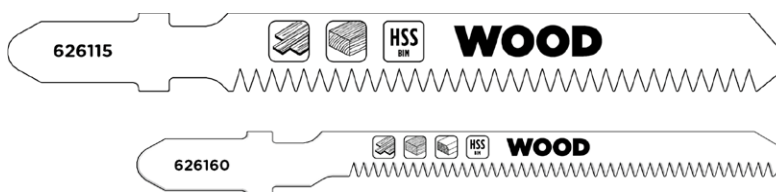

Art.	Gambo	Lunghezza lama	N°pezzi	Tipo taglio	EAN	📦
49626115		60mm	2	Fine	40093162261156	5
49626120		60mm	5	Fine	40093162261200	5
49626160		59mm	2	Curvo	40093162261606	5

LAME PER METALLO

LAME PER SEGHETTO PER METALLO IN LEGA BIMETALLICA HSS



EXPERT

Per metallo, alluminio,
metalli non ferrosi e plastica

626175



METAL

626185



METAL

Art.	Gambo	Lunghezza lama	N°pezzi	Tipo taglio	EAN	📦
49626175		73,5mm	2	Fine	4009316221750	5
49626180		73,5mm	5	Fine	4009316221804	5
49626185		64,5mm	2	Fine	4009316221853	5
49626190		67,5mm	2	Medio	4009316221903	5
49626195		67,5mm	5	Medio	4009316221958	5
49626205		76,5mm	2	Grossolano	4009316222054	5
49626050		108mm	2	Medio	4009316226050	5



LAME MULTIMATERIALE

LAMA PER SEGHETTO IN LEGA BIMETALLICA HSS MULTIMATERIALE DENTATURA VARIA "TWIN-CUT"



PROFESSIONAL

Per metallo, alluminio,
legno da costruzione,
metalli non ferrosi
Adatto al taglio di più materiali

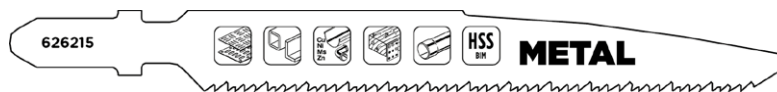

Art.	Gambo	Lunghezza lama	N°pezzi	Tipo taglio	EAN	📦
49626215		75mm	2	Medio	4009316222153	5



LAMA PER SEGHETTO IN LEGA BIMETALLICA HSS MULTIMATERIALE



PROFESSIONAL

Per metallo, alluminio,
legno da costruzione,
metalli non ferrosi
Adatto al taglio di più materiali



Art.	Gambo	Lunghezza lama	N°pezzi	Tipo taglio	EAN	📦
49626035		108mm	2	Medio	4009316226035	5



LAME PER SEGHETTO ALTERNATIVO

LAMA PER SEGHETTO MULTIMATERIALE IN ACCIAIO AL CARBONIO HCS

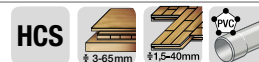

PROFESSIONAL

Per tutti i tipi di legno e plastica
Dentatura progressiva



Art.	Gambo	Lunghezza lama	N°pezzi	Tipo taglio	EAN	
49626015		92mm	2	Medio		5

LAMA PER SEGHETTO IN LEGA BIMETALLICA HSS MULTIMATERIALE

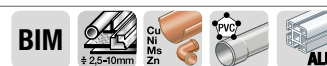

PROFESSIONAL

Per metallo, alluminio e plastica



Art.	Gambo	Lunghezza lama	N°pezzi	Tipo taglio	EAN	
49626025		83mm	2	Fine		5

LAME PER APPLICAZIONI SPECIALI

LAMA PER SEGHETTO PER MATERIALI MORBIDI IN ACCIAIO AL CARBONIO HCS



PROFESSIONAL

Per materiale di isolamento,
polistirolo, gomma e cuoio



Art.	Gambo	Lunghezza lama	N°pezzi	Tipo taglio	EAN	
49626040		127mm	2	Fine		5

LAMA PER SEGHETTO PER PIASTRELLE IN METALLO DURO

PROFESSIONAL

Per piastrelle,
tegole e vetro



Art.	Gambo	Lunghezza lama	N°pezzi	Tipo taglio	EAN	
49626045		57mm	2	Grossolano		5

LAMA PER SEGHETTO PER VETRORESINA E CARTONGESSO CON DENTI IN METALLO DURO



EXPERT

Per plastica e cartongesso



Art.	Gambo	Lunghezza lama	N°pezzi	Tipo taglio	EAN	
49621820		105mm	1	Medio		1

LAMA PER SEGHETTO PER PLEXIGLAS

EXPERT



Art.	Gambo	Lunghezza lama	N°pezzi	Tipo taglio	EAN	
49626235		62mm	2	Fine		5



LAMA PER SEGHETTO PER LEGNO IN LEGA BIMETALLICA CON DENTATURA DOPPIO VERSO



EXPERT

Finitura di taglio extra fine



Art.	Gambo	Lunghezza lama	N°pezzi	Tipo taglio	EAN	
49626245		93mm	2	Fine		5



SET

SET DI LAME PER SEGHETTO PER LEGNO E LAMINATO - 3PZ.

EXPERT



Art.	Gambo	N°pezzi	Tipo taglio	EAN	
49626240		3	Fine		5



SET DI LAME PER SEGHETTO PER LEGNO E METALLO - 6PZ.

EXPERT

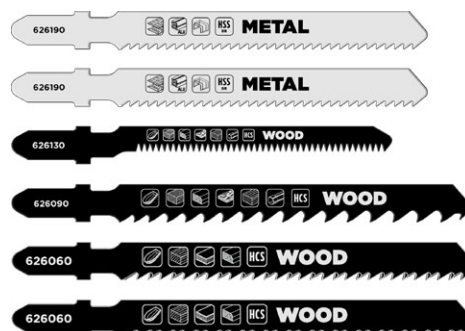

Art.	Gambo	N°pezzi	Tipo taglio	EAN	
49626275		6	Fine-Medio-Gross.		5



LAME PER SEGHETTO ALTERNATIVO

SET DI LAME PER SEGHETTO PER LEGNO E METALLO - 10PZ.

EXPERT

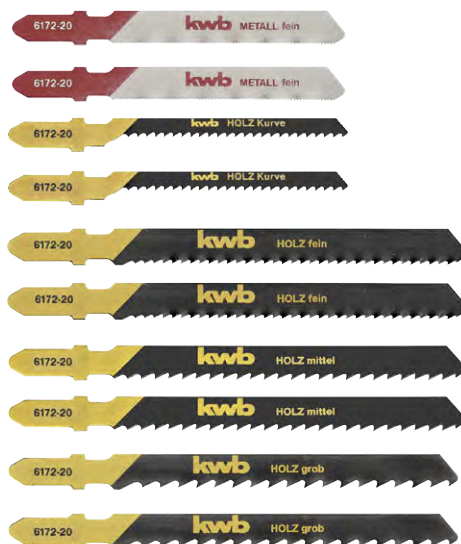

Art.	Gambo	N°pezzi	Tipo taglio	EAN	
49617220		10	Fine-Medio-Gross.		6

SET DI LAME PER SEGHETTO PER LEGNO E LAMINATO - 5PZ.

CLASSIC



Art.	Gambo	N°pezzi	Tipo taglio	EAN	
49617285		5	Fine-Medio-Gross.		6

SET DI LAME PER SEGHETTO PER LEGNO E METALLO - 5PZ.

CLASSIC



Art.	Gambo	N°pezzi	Tipo taglio	EAN	
49617295		5	Fine-Medio-Gross.		6

LAME PER GATTUCCIO



LAME MULTIMATERIALE - RICONDIZIONAMENTO PALLET

LAMA PER GATTUCCIO MULTIMATERIALE DENTATURA A PASSO VARIABILE - 2PZ.



PROFESSIONAL

- Dentatura "Two-Stage"
- Buona dissipazione del calore con poco attrito

Per metallo e legno
da costruzione
Adatto al ricondizionamento
dei pallet
Attacco universale 1/2"



Art.	Lunghezza totale	Lunghezza lama	Tipo taglio	EAN	📦
49571030	150mm	122mm	Fine	4 009 34 571030 3	5



LAMA PER GATTUCCIO MULTIMATERIALE DENTATURA A PASSO VARIABILE - 2PZ.



PROFESSIONAL

Per metallo e legno
da costruzione
Adatto al ricondizionamento
dei pallet
Attacco universale 1/2"



Art.	Lunghezza totale	Lunghezza lama	Tipo taglio	EAN	📦
49571040	203mm	183mm	Fine	4 009 34 571040 3	5



LAME PER SEGNETTO ALTERNATIVO

LAMA PER GATTOCCIO MULTIMATERIALE DENTATURA A PASSO VARIABILE - 2PZ.



PROFESSIONAL

Per metallo e legno da costruzione
Adatto al ricondizionamento dei pallet
Attacco universale 1/2"



Art.	Lunghezza totale	Lunghezza lama	Tipo taglio	EAN	📦
49571050	152mm	120mm	Fine	4009315710501	5

LAMA PER GATTOCCIO MULTIMATERIALE DENTATURA A DOPPIO VERSO - 2PZ.



PROFESSIONAL

Per metallo e legno da costruzione
Adatto al ricondizionamento dei pallet
Attacco universale 1/2"

- Taglio molto veloce
- Doppia durata
- La lama può essere girata una volta usata la prima porzione



Art.	Lunghezza totale	Lunghezza lama	Tipo taglio	EAN	📦
49571025	240mm	220mm	Fine	4009315710259	5

LAMA PER GATTOCCIO MULTIMATERIALE CON DENTI IN METALLO DURO - 2PZ.



PROFESSIONAL

Per metallo e legno da costruzione
Adatto al ricondizionamento dei pallet
Attacco universale 1/2"

- Durata massima



Art.	Lunghezza totale	Lunghezza lama	Tipo taglio	EAN	📦
49571035	152mm	120mm	Grossolano	4009315710358	5

LAME PER METALLO

LAMA PER GATTOCCIO MULTIMATERIALE IN LEGA BIMETALLICA HSS - 2PZ.



EXPERT

- Dentatura rettificata
- Lama molto flessibile

Per metallo e legno da costruzione
Adatto al ricondizionamento dei pallet
Attacco universale 1/2"



Art.	Lunghezza totale	Lunghezza lama	Tipo taglio	EAN	📦
49571100	152	132	Fine	4009315711003	5
49571080	152	132	Medio	4009315710808	5
49571085	230	210	Medio	4009315710853	5
49571105	205	182	Medio	4009315711058	5
49571095	152	132	Grossolano	4009315710952	5

LAME PER EDILIZIA

LAMA PER GATTOCCIO SINGOLA CON DENTI IN METALLO DURO PER CALCESTRUZZO E MATTONI



EXPERT

- Denti in metallo duro
- Utilizzo per cemento, calcestruzzo e mattoni



Art.	Lunghezza totale	Lunghezza lama	Tipo taglio	EAN	📦
49577200	152	130	Grossolano		4

LAMA PER GATTOCCIO SINGOLA CON DENTI IN METALLO DURO PER CALCESTRUZZO E MATTONI



EXPERT

- Denti in metallo duro
- Utilizzo per cemento, calcestruzzo e mattoni



Art.	Lunghezza totale	Lunghezza lama	Tipo taglio	EAN	📦
49577210	230	205	Grossolano		1

LAMA PER GATTOCCIO SINGOLA A BANDIERA CON DENTI IN METALLO DURO PER CALCESTRUZZO E MATTONI



EXPERT

- Denti in metallo duro
- Utilizzo per cemento, calcestruzzo e mattoni



Art.	Lunghezza totale	Lunghezza lama	Tipo taglio	EAN	📦
49577310	305	255	Grossolano		1



LAME PER LEGNO

LAMA PER GATTOCCIO PER LEGNO A DENTATURA GIAPPONESE - 2PZ.



PROFESSIONAL

- Per tutti i tipi di legno
- Dentatura Giapponese
- Attacco universale 1/2"



Art.	Lunghezza totale	Lunghezza lama	Tipo taglio	EAN	📦
49571010	230	210	Fine		5

LAMA PER GATTOCCIO PER LEGNO A DENTATURA PROGRESSIVA - 2PZ.



PROFESSIONAL

- Per tutti i tipi di legno
- Dentatura Giapponese
- Attacco universale 1/2"



Art.	Lunghezza totale	Lunghezza lama	Tipo taglio	EAN	📦
49571065	203	182	Fine		5

LAMA PER GATTOCCIO PER LEGNO - 2PZ.



EXPERT

- Per tutti i tipi di legno
- Attacco universale 1/2"
- Adatto al ricondizionamento dei pallet



Art.	Lunghezza totale	Lunghezza lama	Tipo taglio	EAN	📦
49571090	152	132	Medio		5

LAMA PER GATTOCCIO PER LEGNO - 2PZ.



EXPERT

- Per tutti i tipi di legno
- Attacco universale 1/2"



Art.	Lunghezza totale	Lunghezza lama	Tipo taglio	EAN	📦
49571110	240	220	Grossolano		5

LAMA PER GATTOCCIO PER LEGNO - 2PZ.



EXPERT

- Per tutti i tipi di legno, compensato, truciolato, MDF e plastica
- Attacco universale 1/2"

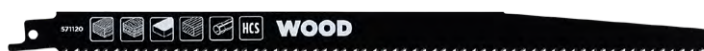

Art.	Lunghezza totale	Lunghezza lama	Tipo taglio	EAN	📦
49571120	305	280	Medio		5

LAMA PER GATTOCCIO PER LEGNO - 2PZ.



EXPERT

- Per tutti i tipi di legno,
- compensato, truciolato, MDF e plastica
- Attacco universale 1/2"



Art.	Lunghezza totale	Lunghezza lama	Tipo taglio	EAN	📦
49571125	152	130	Grossolano		5

LAMA PER GATTOCCIO PER LEGNO - 2PZ.



EXPERT

- Per tutti i tipi di legno,
- compensato, truciolato, MDF e plastica
- Attacco universale 1/2"



Art.	Lunghezza totale	Lunghezza lama	Tipo taglio	EAN	📦
49571130	230	208	Grossolano		5

LAME PER POTATURA E LEGNO VERDE

LAMA PER GATTOCCIO PER LEGNO - 2PZ.

PROFESSIONAL

- Per legno verde, legna da ardere,
- compensato, truciolato, MDF e plastica
- Attacco universale 1/2"



Art.	Lunghezza totale	Lunghezza lama	Tipo taglio	EAN	📦
49571005	242	221	Fine		5

LAMA PER GATTOCCIO PER LEGNO - 2PZ.



EXPERT

- Per potatura e legno verde
- Attacco universale 1/2"



Art.	Lunghezza totale	Lunghezza lama	Tipo taglio	EAN	📦
49571115	240	218	Grossolano		5

LAME PER APPLICAZIONI SPECIALI

LAMA IN ACCIAIO INOX PER MATERIALE CONGELATO - 2PZ.

EXPERT

- Non adatto al taglio di materia organica



Art.	Lunghezza totale	Lunghezza lama	Tipo taglio	EAN	📦
49571135	300	280	Grossolano		5

SET

SET LAME PER GATTOCCIO PER METALLO E LEGNO - 3PZ.



EXPERT

- Set completo, per legno,
- potatura, taglio di profili e lamiere metalliche

1 lama per legno HCS taglio grossolano
 1 lama per legno HCS taglio fine
 1 lama per metallo HSS taglio grossolano



Art.	N°pezzi	Tipo taglio	EAN	📦
49571070	3	Fine-Medio-Gross.		5

SET LAME PER GATTOCCIO PER METALLO E LEGNO - 5PZ.



EXPERT

- Set completo, per legno,
- potatura, taglio di profili e lamiere metalliche

1 lama per legno HCS taglio grossolano
 2 lame per legno HCS taglio fine
 1 lama per metallo HSS taglio grossolano
 1 lama per metallo HSS taglio medio

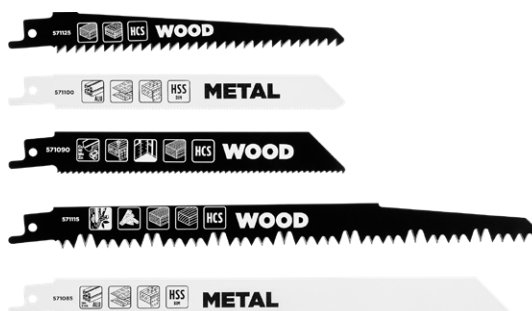

Art.	N°pezzi	Tipo taglio	EAN	📦
49571075	5	Fine-Medio-Gross.		5

SET LAME PER GATTOCCIO PER METALLO E LEGNO CON ASTUCCIO CONTENITORE - 9PZ.



CLASSIC

2 Lame legno 150 mm
 2 Lame legno 228 mm
 4 Lame metallo 150 mm
 Astuccio contenitore



Art.	N°pezzi	Tipo taglio	EAN	📦
49576090	9	Grossolano		4

SET 2 LAME PER GATTOCCIO PER LEGNO E POTATURA IN DISPLAY DA 20 PEZZI



Art.	N°pezzi	Tipo taglio	EAN	📦
49571131	2	Grossolano		20

ACCESSORI PER UTENSILE MULTIFUNZIONE



LAME MULTIMATERIALE

LAMA AD IMMERSIONE DRITTA CON RIVESTIMENTO IN TITANIO E DENTI IN METALLO DURO



PROFESSIONAL

- Denti in metallo duro
- Rivestimento in Titanio
- Durata massimizzata
- Prestazioni ottimizzate

*Per applicazioni pesanti,
adatto su metallo, chiodi,
legno e mattoni*
Attacco universale
Con rivestimento antiaderente PTFE



Art.	Profondità	Larghezza	Materiale	EAN	
49708063	42mm	35mm	Acciaio HSS BiM		1

LAMA AD IMMERSIONE DRITTA CON RIVESTIMENTO IN TITANIO 29MM



PROFESSIONAL

- Rivestimento in Titanio
- Durata massimizzata
- Prestazioni ottimizzate

*Per applicazioni pesanti,
adatto su metallo, chiodi,
legno e mattoni*
Attacco universale
Con rivestimento
antiaderente PTFE



Art.	Profondità	Larghezza	Materiale	EAN	
49708052	54mm	29mm	Acciaio HSS BiM		5

LAMA AD IMMERSIONE DRITTA CON RIVESTIMENTO IN TITANIO 45MM



PROFESSIONAL

- Rivestimento in Titanio
- Durata massimizzata
- Prestazioni ottimizzate

*Per applicazioni pesanti,
adatto su metallo, chiodi,
legno e mattoni*
Attacco universale
Con rivestimento
antiaderente PTFE



Art.	Profondità	Larghezza	Materiale	EAN	
49708054	57mm	45mm	Acciaio HSS BiM		5

LAMA AD IMMERSIONE SEMICIRCOLARE CON RIVESTIMENTO IN TITANIO

PROFESSIONAL

- Rivestimento in Titanio
- Durata massimizzata
- Prestazioni ottimizzate

Per applicazioni pesanti, adatto su lamiere e tubi metallici, legno e legno con chiodi.
Attacco universale
Con rivestimento antiaderente PTFE



Art.	Ø	Materiale	EAN	
49708058	88mm	Acciaio HSS BiM	4009317080589	5

LAMA AD IMMERSIONE SEMICIRCOLARE CON RIVESTIMENTO IN TITANIO

PROFESSIONAL

- Rivestimento in Titanio
- Durata massimizzata
- Prestazioni ottimizzate

Per applicazioni pesanti, adatto su lamiere e tubi metallici, legno e legno con chiodi.
Attacco universale
Con rivestimento antiaderente PTFE



Art.	Ø	Materiale	EAN	
49708059	100mm	Acciaio HSS BiM	4009317080596	5

PER PIASTRELLE E CERAMICA

LAMA DIAMANTATA PER PIASTRELLE E CERAMICA

- Lama diamantata
- Durata massimizzata
- Prestazioni ottimizzate

Per piastrelle e ceramica per raggiungere i punti più difficili
Attacco universale



Art.	Larghezza	Spessore	Materiale	EAN	
49708085	57mm	1,5mm	Acciaio HSS BiM	4009317080853	5

LAMA DIAMANTATA SEMICIRCOLARE PER PIASTRELLE E CERAMICA

- Lama diamantata
- Durata massimizzata
- Prestazioni ottimizzate

Per piastrelle e ceramica per raggiungere i punti più difficili
Attacco universale



Art.	Ø	Materiale	EAN	
49708086	65mm	Acciaio HSS BiM	4009317080862	5

RASPA TRIANGOLARE A PUNTA IN METALLO DURO

- Abrasivo in carburo di tungsteno
- Prestazioni ottimizzate

Per piastrelle e ceramica per raggiungere i punti più difficili
Attacco universale

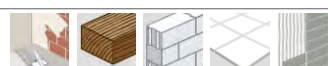

Art.	Profondità	Spessore	Materiale	EAN	
49708073	41mm	34mm	Acciaio HSS BiM	4009317080732	5

RASPA TRIANGOLARE IN METALLO DURO

- Abrasivo in carburo di tungsteno
- Prestazioni ottimizzate

Per piastrelle, intonaco colla per piastrelle, legno e vetrocemento per raggiungere i punti più difficili
Attacco universale



Art.	Profondità	Larghezza	Materiale	EAN	
49708070	80mm	80mm	Acciaio HSS BiM		5

LAMA IN METALLO DURO PER PIASTRELLE E CERAMICA

- Lama in carburo di tungsteno
- Prestazioni ottimizzate

per piastrelle e ceramica per raggiungere i punti più difficili
Attacco universale

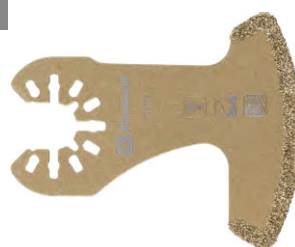

Art.	Larghezza	Spessore	Materiale	EAN	
49708075	57mm	2,0mm	Acciaio HSS BiM		5

LAMA IN METALLO DURO SEMICIRCOLARE PER PIASTRELLE E CERAMICA

- Lama in carburo di tungsteno
- Prestazioni ottimizzate

per piastrelle, ceramica, colla per piastrelle e vetrocemento
Attacco universale



Art.	Ø	Materiale	EAN	
49708078	87mm	Acciaio HSS BiM		5

PER METALLO

LAMA AD IMMERSIONE PER METALLO DRITTA 10MM

- Prestazioni ottimizzate
- Lama dritta

Per lamiere e tubi metallici, metalli non-ferrosi, legno e legno con chiodi.
Attacco universale
Con rivestimento antiaderente PTFE



Art.	Profondità	Larghezza	Materiale	EAN	
49708041	42mm	10mm	Acciaio HSS BiM		5

LAMA AD IMMERSIONE PER METALLO DRITTA 22MM

- Prestazioni ottimizzate
- Lama dritta

Per lamiere e tubi metallici, metalli non-ferrosi, legno e legno con chiodi.
Attacco universale
Con rivestimento antiaderente PTFE



Art.	Profondità	Larghezza	Materiale	EAN	
49708042	48mm	22mm	Acciaio HSS BiM		5

LAMA AD IMMERSIONE PER METALLO CURVA 34MM

- Prestazioni ottimizzate
- Lama curva

Per lamiere e tubi metallici,
metalli non-ferrosi,
legno e legno con chiodi.
Attacco universale
Con rivestimento
antiaderente PTFE

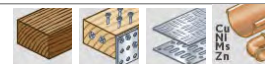

Art.	Profondità	Larghezza	Materiale	EAN	
49708043	40mm	34mm	Acciaio HSS BiM	4009317080433	5

LAMA AD IMMERSIONE PER METALLO CURVA 65MM

- Prestazioni ottimizzate
- Lama curva

Per lamiere e tubi metallici,
metalli non-ferrosi,
legno e legno con chiodi.
Attacco universale
Con rivestimento
antiaderente PTFE



Art.	Profondità	Larghezza	Materiale	EAN	
49708046	42mm	65mm	Acciaio HSS BiM	4009317080462	5

LAMA AD IMMERSIONE SEMICIRCOLARE PER METALLO

- Prestazioni ottimizzate

Per lamiere e tubi metallici,
metalli non-ferrosi,
legno e legno con chiodi.
Attacco universale
Con rivestimento
antiaderente PTFE



Art.	Ø	Materiale	EAN	
49708048	88mm	Acciaio HSS BiM	4009317080480	5

PER LEGNO

LAMA AD IMMERSIONE HCS PER LEGNO DRITTA 10MM

- Prestazioni ottimizzate
- Lama dritta

Per legno, plastica e
cartongesso
Attacco universale
Con rivestimento
antiaderente PTFE



Art.	Profondità	Larghezza	Materiale	EAN	
49708021	42mm	10mm	Acciaio HCS	4009317080211	5

LAMA AD IMMERSIONE HCS PER LEGNO DRITTA 22MM

- Prestazioni ottimizzate
- Lama dritta

Per legno, plastica e
cartongesso
Attacco universale
Con rivestimento
antiaderente PTFE



Art.	Profondità	Larghezza	Materiale	EAN	
49708022	48mm	22mm	Acciaio HCS	4009317080228	5

LAMA AD IMMERSIONE HCS PER LEGNO CURVA 32MM

- Prestazioni ottimizzate
- Lama curva

*Per legno, plastica e cartongesso
Attacco universale
Con rivestimento antiaderente PTFE*



Art.	Profondità	Larghezza	Materiale	EAN	
49708023	40mm	32mm	Acciaio HCS	4009317080237	5

LAMA AD IMMERSIONE HCS LEGNO CURVA 65MM

- Prestazioni ottimizzate
- Lama curva

*Per legno, plastica e cartongesso
Attacco universale
Con rivestimento antiaderente PTFE*



Art.	Profondità	Larghezza	Materiale	EAN	
49708026	42mm	65mm	Acciaio HCS	4009317080268	5

LAMA AD IMMERSIONE HCS PER LEGNO CURVA DENTATURA GIAPPONESE 32MM

- Prestazioni ottimizzate
- Lama curva
- Dentatura Giapponese
- Taglio molto preciso

*Per legno, plastica e cartongesso
Attacco universale
Con rivestimento antiaderente PTFE*



Art.	Profondità	Larghezza	Materiale	EAN	
49708033	40mm	32mm	Acciaio HCS	4009317080339	5

LAMA AD IMMERSIONE HCS PER LEGNO CURVA DENTATURA GIAPPONESE 65MM

- Prestazioni ottimizzate
- Lama curva
- Dentatura Giapponese
- Taglio molto preciso

*Per legno, plastica e cartongesso
Attacco universale
Con rivestimento antiaderente PTFE*



Art.	Profondità	Larghezza	Materiale	EAN	
49708036	42mm	65mm	Acciaio HCS	4009317080360	5

ALTRI ACCESSORI

RASCHIETTO IN ACCIAIO HCS A PUNTA

*Per silicone e residui di moquette
Attacco universale*

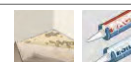

Art.	Profondità	Larghezza	Materiale	EAN	
49708001	50mm	-	Acciaio HCS	4009317080015	5

RASCHIETTO IN ACCIAIO HCS RIGIDO

Per silicone, residui di moquette
colla per piastrelle e intonaco
Attacco universale



Art.	Profondità	Larghezza	Materiale	EAN	
49708002	26mm	52mm	Acciaio HCS		5

RASCHIETTO IN ACCIAIO HCS FLESSIBILE

Per silicone, residui di moquette
colla per piastrelle e intonaco
Attacco universale

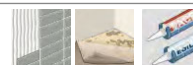

Art.	Profondità	Larghezza	Materiale	EAN	
49708003	45mm	52mm	Acciaio HCS		5

PLATORELLO TRIANGOLARE PER MULTIFUNZIONE VELCRATO

Velcrato
Attacco universale

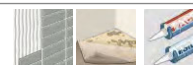

Art.	Lunghezza Lato	EAN	
49708093	93mm		5

SET

SET DI LAME AD IMMERSIONE PER LEGNO E METALLO - 3PZ.

- Set completo per metallo e legno

Per legno, legno da costruzione, lamiera, tubi metallici e chiodi.
Attacco universale
Con rivestimento antiaderente PTFE



Art.	N°pezzi	EAN	
49708103	3		5

SET DI ACCESSORI PER MULTIFUNZIONE - 4PZ.



- 2 lame per metallo
- 1 lama per legno con raschietto

*Per legno, legno da costruzione, lamiere, tubi metallici e chiodi.
Attacco universale*

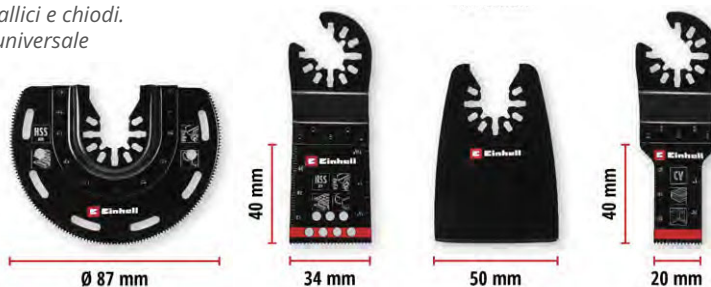

Art.	N°pezzi	EAN	
49708104	4		5

SET DI ACCESSORI PER MULTIFUNZIONE - 6PZ.



- Set completo
- 2 lame per legno
- 1 lama per metallo
- 2 accessori per piastrellista con raschietto

*Per legno, legno da costruzione, lamiere, tubi metallici e chiodi.
Attacco universale*



Art.	N°pezzi	EAN	
49708106	6		5

SET DI ACCESSORI PER IL PIASTRELLISTA - 3PZ.



- Set completo per piastrellista
- Lama diamantata semicircolare
- Lama in metallo duro semicircolare
- Raspa triangolare in metallo duro

*Per piastrelle, ceramica e gres porcellanato
Attacco universale*



Art.	N°pezzi	EAN	
49708113	3		5

SET DI LAME AD IMMERSIONE E CARTA ABRASIVA PER LEGNO E METALLO - 17PZ.



- Set completo con raschietto rigido, platorello veltrato e carta abrasiva

*Per legno, metallo e gres porcellanato
Attacco universale*

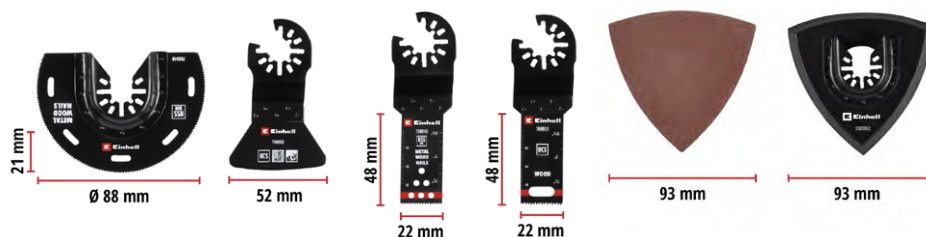

Art.	N°pezzi	EAN	
49708117	17		5

LAME PER SEGHE CIRCOLARI



PER MACCHINE PORTATILI

LAMA CIRCALE PER LEGNO M23

EXPERT

- Denti in carburo di Tungsteno
- Max. 13600 rpm



Art.	Ø x alloggiamento	Spessore	Z (N°denti)	EAN	📦
49582357	D.140 x 12,75mm	1,4mm	18	4009315823577	1

LAME CIRCOLARI PER LEGNO TAGLIO FINE

EXPERT

- Taglio rapido e fine
- Denti alternati
- Per piani di lavoro del legno



Art.	Ø x alloggiamento	Spessore	Z (N°denti)	EAN	📦
49587151	D.200 x 16mm	1,6mm	20	4009315871512	1
49587857	D.210 x 30mm	1,6mm	30	4009315878570	5
49587852	D.210 x 30mm	1,2mm	40	4009315878523	1
49587856	D.210 x 30mm	1,3mm	48	4009315878561	1
49587861	D.210 x 30mm	1,6mm	48	4009315878611	1
49587868	D.210 x 30mm	1,2mm	64	4009315878683	1

LAME CIRCOLARI PER LEGNO TAGLIO FINE



EXPERT

- Taglio rapido e fine
- Denti alternati
- Per piani di lavoro del legno



Art.	Ø x alloggiamento	Spessore	Z (N°denti)	EAN	📦
49584511	D.160 x 20mm	1,4mm	100	4009315845111	1

LAME CIRCOLARI PER TRUCIOLATI

CLASSIC

- Taglio rapido e pulito
- Denti alternati

Per legno duro, legno tenero, pannelli di compensato, truciolato e melamina



Art.	Ø x alloggiamento	Spessore	Z (N°denti)	EAN	📦
49584357	D.160 x 16mm	1,4mm	20	4009315843573	1
49584557	D.160 x 20mm	1,4mm	20	4009315845573	1
49584568	D.160 x 20mm	1,4mm	48	4009315845685	1
49584754	D.165 x 20mm	1,4mm	24	4009315847542	1
49585457	D.170 x 30mm	1,4mm	22	4009315854571	5
49586557	D.190 x 16mm	1,4mm	30	4009315865577	1
49586757	D.190 x 20mm	1,4mm	30	4009315867571	5
49586959	D.190 x 30mm	1,4mm	30	4009315869599	1
49587157	D.200 x 16mm	1,6mm	30	4009315871578	5



LAME PER SEGHE CIRCOLARI

LAMA CIRCOLARE PER LEGNO EXTRASOTTILE

EXPERT

- Tagli molto fini
- Denti alternati



Art.	Ø x alloggiamento	Spessore	Z (N°denti)	EAN	📦
49586956	D.190x30mm	1,3mm	30	4009315869568	1

SET DI LAME PER SEGA CIRCOLARE 210X30MM CON RIDUTTORI INCLUSI - 3PZ.

EXPERT

- Tagli molto fini
- Denti alternati



Art.	Ø x alloggiamento	Spessore	Z (N°denti)	EAN	📦
49587895	D.210x30mm	1,6mm	24-36-60	4009315878959	2

SET DI LAME PER SEGA CIRCOLARE 190X30MM CON RIDUTTORI INCLUSI

EXPERT

- Tagli molto fini
- Denti alternati

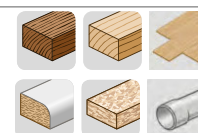

Art.	Ø x alloggiamento	Spessore	Z (N°denti)	EAN	📦
49586995	D.190x30mm	1,6mm	24-36-60	4009315869959	2

PER MACCHINE STAZIONARIE

LAMA CIRCOLARE PER MACCHINE STAZIONARIE

CLASSIC

- Tagli rapidi e puliti
- Denti alternati

Per legno, pannelli,
MDF, DM.



Art.	Ø x alloggiamento	Spessore	Z (N°denti)	EAN	📦
49588257	D.216 x 30	1,6mm	30	4009315882572	1
49588268	D.216 x 30	1,8mm	64	4009315882680	1
49589341	D.250 x 30	2,2mm	24	4009315893410	1
49589351	D.250 x 30	2,2mm	48	4009315893518	1
49589552	D.250 x 30	2,2mm	60	4009315895520	1
49589311	D.250 x 30	2,2mm	80	4009315893112	1
49589300	D.250 x 30	2,2mm	120	4009315893002	1
49589551	D.254 x 30	2,2mm	48	4009315895512	1
49589561	D.254 x 30	2,2mm	60	4009315895611	1
49593059	D.300 x 30	2,2mm	48	4009315930592	1



LAME PER MINI SEGA

SET DI LAME PER MINI SEGA CIRCOLARE - 3PZ.

PROFESSIONAL

- Con chiave e rondella
- Ideale per parquet

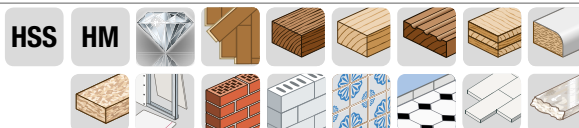

Art.	Ø esterno	Ø interno	N°pezzi	EAN	📦
49575905	85mm	10mm	3	4009315759050	1

ANELLO RIDUTTORE

EXPERT



Art.	Ø esterno	Ø interno	Spessore	EAN	📦
49582016	20mm	16mm	1,2mm	4009315820163	1
49583016	30mm	16mm	1,2mm	4009315830162	1
49583020	30mm	20mm	1,2mm	4009315830200	1
49583025	30mm	25mm	1,2mm	4009315830254	1



LAMA PER FRESATRICE ORIZZONTALE



LAMA PER FRESATRICE ORIZZONTALE

HM



Art.	Ø x alloggiamento	Spessore	Z (N°denti)	EAN	
49758941	D.100 x 22mm	3,0mm	6		1

LAME PER PIALLA





COPPIA DI LAME PER PIALLETTO

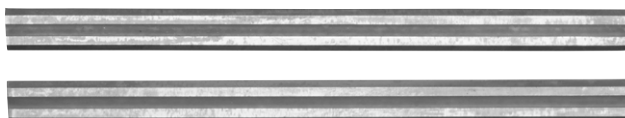

PROFESSIONAL

- Doppio filo tagliente dritto
- Lame rettificate



Art.	Lung. totale	Larghezza	Spessore	EAN	
49568302	82mm	5,5mm	1,1mm		5
49568315	82mm	5,5mm	1,1mm		1





LAMA PER PIALLA A FILO E SPESSORE



PROFESSIONAL

- Lame rettificate



Art.	Lung. totale	Larghezza	Spessore	EAN	
49568602	210mm	17mm	1,5mm		1

LAME PER TRAFORO OSCILLANTE





LAME PER TRAFORO OSCILLANTE

PROFESSIONAL

Per legno tenero e materiali sintetici



Art.	Lung. totale	Lunghezza lama	N°pezzi	EAN	
49316350	130mm	100mm	5		1
49316352	130mm	100mm	10		1



STRUMENTI PER FALEGNAMERIA



ELEMENTI DI COLLEGAMENTO

SET COMPLETO PER SPINATURA

PROFESSIONAL

- Dispositivo per spinatura professionale
- 150 spine in legno
- 3 punte per legno in CV

*Per legno, pannelli, melamina
MDF, DM e legno duro
Arresto parallelo,
fori a 90° da 3 a 12mm*



Art.	Ø spine	Lunghezza	N° spine	EAN	
49758100	6, 8, 10 mm	6, 8, 10 mm	150		2



SPINE IN LEGNO SCANALATE 30MM

PROFESSIONAL

- Legno di faggio
- Scanalato e smussato
- Per unire mobili

Per legno, pannelli, melamina



Art.	Ø spine	Lunghezza	N° spine	EAN	
49028160	6mm	30mm	50		10
49028180	8mm	30mm	40		10
49028200	10mm	30mm	30		10

SET PER SPINATURA E SPIGOLATURA

PROFESSIONAL

- 4 punte per spigolatura con Arresto di profondità



CV



Art.	Ø spine	Ø punta	N° spine	EAN	
49028066	6,0mm	6,0mm	25	4009310280665	10
49028086	8,0mm	8,0mm	25	4009310280863	10
49028106	10,0mm	10,0mm	20	4009310281068	10



LAMELLI SPESSORE 4 MM

PROFESSIONAL

- Legno di faggio
- 4 mm spessore per giunzione mobili

Per legno, pannelli, melamina



Art.	Dimensioni	Tipo fresatura	N° pezzi	EAN	
49029100	15x4mm	0	50	4009310291005	6
49029110	19x4mm	10	50	4009310291104	6
49029120	23x4mm	20	50	4009310291203	6



MARCATORI PER SPIGOLATURA

EXPERT

- Punte per la marcatura degli spigoli

Per legno, pannelli, melamina



Art.	Ø	N° pezzi	EAN	
49530206	6mm	4	4009315302065	10
49530208	8mm	4	4009315302089	10
49530210	10mm	4	4009315302102	10



STRUMENTI PER FISSAGGIO

STRETTOIO REVERSIBILE

CLASSIC

- Sblocco rapido
- Regolazione precisa
- Pressione interna ed esterna



Art.	Larghezza	Profondità	EAN	
49930015	150mm	35mm	4009319300159	6
49930030	300mm	35mm	4009319300302	6



STRETTOIO IN ZINCO PRESSOFUSO

CLASSIC

- Solido e resistente

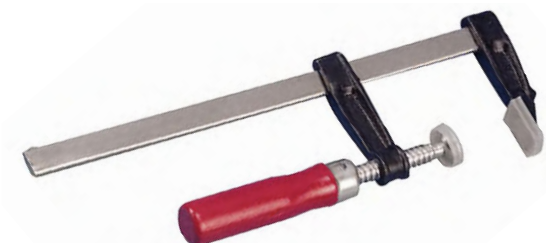

Art.	Larghezza	Profondità	EAN	
49928320	200mm	50mm		10
49928330	300mm	50mm		10

MINI MORSETTI L 60MM

CLASSIC



Art.	Serraggio	Lunghezza	EAN	
49927529	25mm	60mm		50

SET MORSETTI L 90MM - 4PZ.

CLASSIC



Art.	Serraggio	Lunghezza	EAN	
49927540	30mm	90mm		6

MORSETTI SINGOLI L120MM

CLASSIC



Art.	Larghezza	Profondità	EAN	
49927591	50mm	120mm		10
49927891	100mm	120mm		10
49927991	150mm	120mm		10
49928091	225mm	120mm		10

PISTOLA PER COLLA A CALDO PER STICK DA 11 MM

CLASSIC

- Tempo di riscaldamento 3min
- Cavo da 1,4m
- Certificata TUV/GS

*Per metallo, legno, plastica e cuoio
Inclusi 2 tubi da 11 mm*



Art.	Ø stick	Potenza	Temperatura	EAN	
49989490	11mm	30W	195°		6

STICK DI COLLA A CALDO

EXPERT

- Elevata forza adesiva
- Per metallo, legno, plastica e cuoio



Art.	Ø stick	Lung. stick	N°pezzi	EAN	
49538906	7mm	100mm	6		6
49538955	7mm	150mm	24		1
49539006	11mm	100mm	6		6
49539355	11mm	200mm	24		1

CHIODI TYP 047/055 - 1000 PZ.

Adatti all'uso con:
TC-EN 20 E



Art.	Lunghezza	Tipo	N°pezzi	EAN	
49355614	14mm	047/055	1000		1

GRAFFETTE TYP 053 - 1000 PZ.

Adatte all'uso con:
TC-EN 20 E
TC-CT 3,6 Li



Art.	Dimensioni	Tipo	N°pezzi	EAN	
49353508	11,4x8mm	053	1000		1

SGORBIE E SCALPELLI PER LEGNO

SET DI SCALPELLI IN CV CON MANICO IN LEGNO - 4PZ.

CLASSIC

- Cromo-Vanadio
- Extra affilati
- Legno di faggio rosso

Per legno duro e tenero



Art.	Larghezza punta	EAN	
49455400	6-12-18-24mm		1

SET DI SGORBIE ASSORTITE - 5PZ.

PROFESSIONAL

- Cromo-Vanadio
- Extra affilati
- Legno di faggio rosso

Per legno duro e tenero



Art.	N°pezzi	EAN	
49455250	5		

CARTA ABRASIVA



PER LEVIGATRICI DA MURO

RETE ABRASIVA CON VELCRO PER LEVIGATRICE DA MURO 225MM



EXPERT

- Grana in carburo di silicio
- resistente all'acqua con velcro

*Dura fino a 4 volte in più della normale carta abrasiva
Si pulisce con aria compressa o acqua*

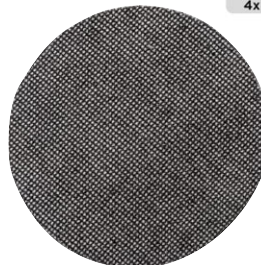

Art.	Ø	Grana	N°pezzi	EAN	📦
49491508	225mm	80	5	40093142215082	5
49491512	225mm	120	5	40093142215122	5
49491522	225mm	220	5	40093142215222	5



DISCHI ABRASIVI FORATI CON VELCRO 225 MM - 5PZ.



PROFESSIONAL

- Corindone bianco con velcro

Per cartongesso, legno vernice, stucco e metallo

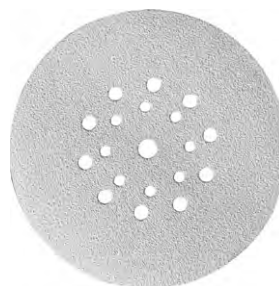

Art.	Ø	Grana	N°pezzi	EAN	📦
49492104	225mm	40	5	40093142211045	5
49492108	225mm	80	5	40093142211085	5
49492112	225mm	120	5	40093142211120	5
49492118	225mm	180	5	40093142211182	5



SET DI RETI ABRASIVE PER LEVIGATRICE DA MURO CIRCOLARI E TRIANGOLARI - 5PZ.



PROFESSIONAL

- Grana in carburo di silicio resistente all'acqua con velcro

*Dura fino a 4 volte in più della normale carta abrasiva
Si pulisce con aria compressa o acqua*

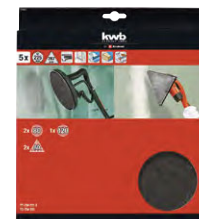
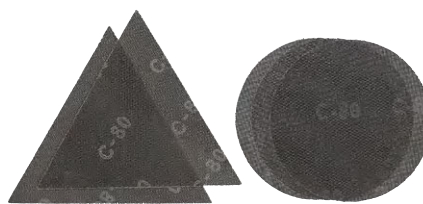

Art.	Ø	Grana	N°pezzi	EAN	
49491005	225mm	80, 120	5		1

SET DI DISCHI FORATI E RETI ABRASIVE CON VELCRO - 15PZ.



PROFESSIONAL

- Per cartongesso, legno, metallo e vernice
- Con velcro

*Composizione:
Reti abrasive: 4x Gr.80, 2x Gr. 120
Corindone bianco: 4x Gr.80, 2x Gr. 120
Corindone: 2x Gr.80, 1x Gr. 120*



Art.	Ø	Grana	N°pezzi	EAN	
49491066	225mm	80-120	15		1

SET DI RETI ABRASIVE PER LEVIGATRICE DA MURO TRIANGOLARI 287MM - 5PZ.



PROFESSIONAL

- Per cartongesso, legno, metallo e vernice
- Con velcro

*Composizione:
Reti abrasive: 2x Gr.80
Corindone bianco: 2x Gr.80
Corindone: 1x Gr.80*

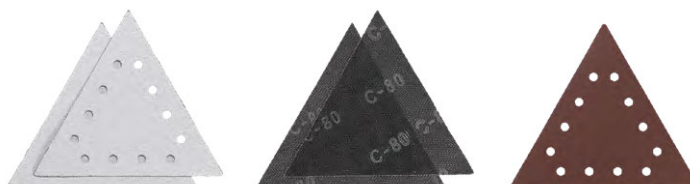

Art.	Lato	Grana	N°pezzi	EAN	
49491075	287mm	80	5		1

SET DI RETI E CARTE ABRASIVE CIRCOLARI E TRIANGOLARI PER LEVIGATRICE DA MURO - 15PZ.



PROFESSIONAL

- Per cartongesso, legno, metallo e vernice
- Con velcro

*Composizione:
Reti abrasive tonde: 3x P80, 1x P120
Reti abrasive triangolari: 2x P80
Corindone bianco tondo: 4x P80, 1x P120
Corindone bianco triangolare: 2x P80
Corindone tondo: 1x P80
Corindone triangolare: 1x P80*

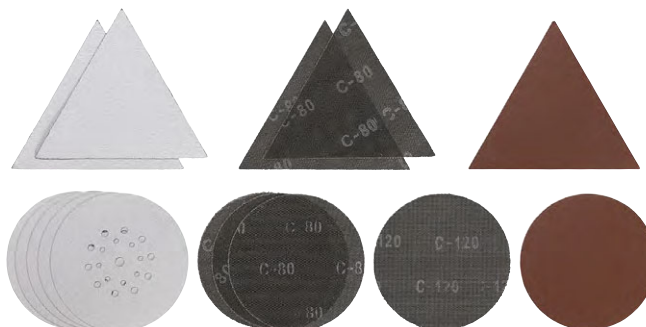

Art.	Formato	Grana	N°pezzi	EAN	
49491065	Ø225mm, l.287mm	80-120	15		1

SET DI RETI ABRASIVE CIRCOLARI ASSORTITE 180MM - 5PZ.



PROFESSIONAL

- Per cartongesso, legno, metallo e vernice
- Con velcro

Composizione:
Reti abrasive tonde:
3x P80, 2x P120

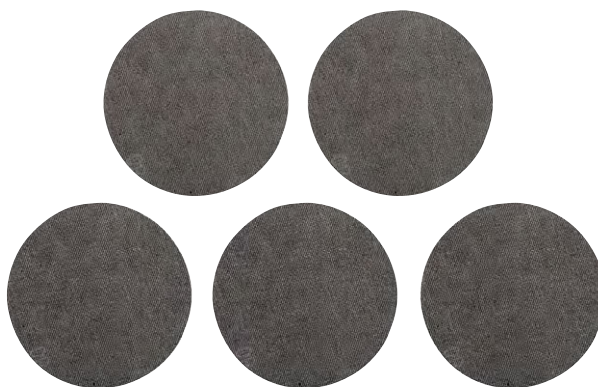

Art.	Ø	Grana	N°pezzi	EAN	
49490905	180mm	80-120	5		1



SET DI RETI ABRASIVE CIRCOLARI ASSORTITE 180MM - 5PZ.



PROFESSIONAL

- Per cartongesso, legno, metallo e vernice
- Con velcro

Composizione:
Reti abrasive: 4x P80, 2x P120
Corindone bianco: 4x P80, 2x P120
Corindone: 2x P80, 1x P120

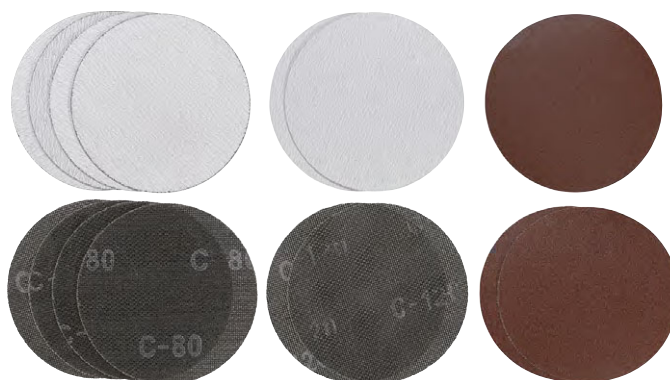

Art.	Ø	Grana	N°pezzi	EAN	
49490965	180mm	80-120	5		1



PER LEVIGATRICI ORBITALI RETTANGOLARI

RETI ABRASIVE PER LEVIGATRICI ORBITALI 93 X 230 MM - 5PZ.



EXPERT

- Grana in carburo di silicio resistente all'acqua con velcro

Dura fino a 4 volte in più
della normale carta abrasiva
Si pulisce con aria compressa o acqua

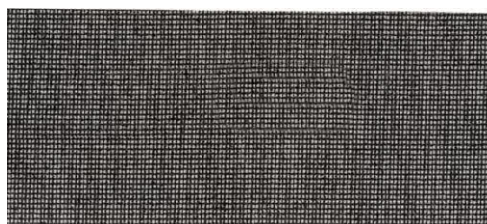

Art.	Formato	Grana	N°pezzi	EAN	
49857008	93 x 230mm	80	5		5
49857012	93 x 230mm	120	5		5
49857022	93 x 230mm	220	5		5





STRISCE ABRASIVE PER LEVIGATRICE ORBITALE SENZA FORI E SENZA VELCRO 115 X 280MM



EXPERT



Per legno, metallo e vernice

Art.	Formato	Grana	N°pezzi	EAN	
49812040	115 x 280mm	40	10		5
49812080	115 x 280mm	80	10		10
49812120	115 x 280mm	120	10		10
49812240	115 x 280mm	240	10		10



STRISCE ABRASIVE PER LEVIGATRICE ORBITALE FORATE ASSORTITE SENZA VELCRO 115X280MM - 30PZ.



Per legno, metallo e vernice
Composizione: 7xP40, 7xP80,
8xP120 e 8xP180



Art.	Formato	Grana	N°pezzi	EAN	
49818788	115 x 280mm	40-80-120-180	30		5



STRISCE ABRASIVE PER LEVIGATRICE ORBITALE FORATE CON VELCRO 115X230MM



EXPERT



Per legno, metallo e vernice

Art.	Formato	Grana	N°pezzi	EAN	
49818904	115 x 230mm	40	5		5
49818908	115 x 230mm	80	5		5
49818912	115 x 230mm	120	5		5
49818918	115 x 230mm	180	5		5
49818924	115 x 230mm	240	5		5



STRISCE ABRASIVE PER LEVIGATRICE ORBITALE FORATE SENZA VELCRO 93X230MM



EXPERT

Per legno, metallo e vernice



Art.	Formato	Grana	N°pezzi	EAN	
49818204	93 x 230mm	40	10		10
49818206	93 x 230mm	60	10		10
49818208	93 x 230mm	80	10		10
49818212	93 x 230mm	120	10		10
49818288	93 x 230mm	40-80-120-180	30		5

STRISCE ABRASIVE PER LEVIGATRICE ORBITALE FORATE SENZA VELCRO 93 X 230MM



EXPERT

Per legno, metallo e vernice



Art.	Formato	Grana	N°pezzi	EAN	
49818104	93 x 230mm	40	10		10
49818108	93 x 230mm	80	10		10
49818124	93 x 230mm	240	10		10
49818188	93 x 230mm	40-80-120-180	30		5

STRISCE ABRASIVE PER LEVIGATRICE ORBITALE SENZA FORI E SENZA VELCRO 93 X 230MM



EXPERT

Per legno, metallo e vernice



Art.	Formato	Grana	N°pezzi	EAN	
49815040	93 x 230mm	40	10		5
49815060	93 x 230mm	60	10		10
49815080	93 x 230mm	80	10		10
49815120	93 x 230mm	120	10		10
49815180	93 x 230mm	180	10		10
49815240	93 x 230mm	240	10		10

STRISCE ABRASIVE PER LEVIGATRICE ORBITALE FORATE CON VELCRO 93 X 185MM



EXPERT

Per legno, metallo e vernice



Art.	Formato	Grana	N°pezzi	EAN	
49817904	93 x 185mm	40	5		5
49817906	93 x 185mm	60	5		5
49817908	93 x 185mm	80	5		5
49817912	93 x 185mm	120	5		5
49817918	93 x 185mm	180	5		5
49817924	93 x 185mm	240	5		5

STRISCE ABRASIVE PER LEVIGATRICE ORBITALE FORATE CON VELCRO 93 X 185MM



EXPERT



Per legno, metallo e vernice

Art.	Formato	Grana	N°pezzi	EAN	
49818304	93 x 185mm	40	5	4009318183042	5
49818300	93 x 185mm	60	5	4009318183002	5
49818308	93 x 185mm	80	5	4009318183081	5
49818312	93 x 185mm	120	5	4009318183122	5
49818318	93 x 185mm	180	5	4009318183180	5
49818324	93 x 185mm	240	5	4009318183241	5
49818388	93 x 185mm	40-80-240	15	4009318183882	5



STRISCE ABRASIVE PER LEVIGATRICE ORBITALE FORATE ASSORTITE CON VELCRO - 10PZ.



EXPERT



Per legno, metallo e vernice

Composizione: 3xP40, 4xP80 e 3xP240

Art.	Formato	Grana	N°pezzi	EAN	
49817980	93 x 185mm	40-80-240	10	4009318179800	5



STRISCE ABRASIVE PER LEVIGATRICE ORBITALE FORATE CON VELCRO 115 X 100MM



EXPERT



Per legno, metallo e vernice

Art.	Formato	Grana	N°pezzi	EAN	
49818004	115 x 100mm	40	5	4009318180042	5
49818008	115 x 100mm	80	5	4009318180080	5
49818012	115 x 100mm	120	5	4009318180127	5



ROTOLO DI CARTA ABRASIVA 5 METRI X 115 MM



EXPERT

- per levigatrice orbitale senza velcro o levigatura manuale



Per legno, metallo vernice,
plastica lacca e stucco

Art.	Formato	Grana	EAN	
49817804	5m x 115mm	40	4009318178042	1
49817806	5m x 115mm	60	4009318178062	1
49817808	5m x 115mm	80	4009318178087	1
49817812	5m x 115mm	120	4009318178124	1
49817818	5m x 115mm	180	4009318178182	1
49817824	5m x 115mm	240	4009318178249	1



ROTOLO DI CARTA ABRASIVA 5 METRI X 93 MM

EXPERT

- per levigatrice orbitale senza velcro o levigatura manuale

Per legno, metallo vernice,
plastica lacca e stucco



Art.	Formato	Grana	EAN	
49817704	5m x 93mm	40		1
49817706	5m x 93mm	60		1
49817708	5m x 93mm	80		1
49817712	5m x 93mm	120		1
49817718	5m x 93mm	180		1
49817724	5m x 93mm	240		1



PER LEVIGATRICI ORBITALI TRIANGOLARI

TRIANGOLI DI RETE ABRASIVA PER LEVIGATRICE PALMARE 100X62X93MM

EXPERT

- Grana in carburo di silicio resistente all'acqua con velcro

Dura fino a 4 volte in più della normale carta abrasiva
Si pulisce con aria compressa o acqua
Foglio divisibile



Art.	Formato	Grana	N°pezzi	EAN	
49496308	100x62x93mm	80	5		5
49496312	100x62x93mm	120	5		5
49496322	100x62x93mm	220	5		5



TRIANGOLI DI RETE ABRASIVA PER LEVIGATRICE PALMARE 97X136MM

EXPERT

- Grana in carburo di silicio resistente all'acqua con velcro

Dura fino a 4 volte in più della normale carta abrasiva
Si pulisce con aria compressa o acqua
Foglio divisibile



Art.	Formato	Grana	N°pezzi	EAN	
49492212	97 x 136 mm	120	5		5
49492222	97 x 136 mm	220	5		5



TRIANGOLI ABRASIVI PER LEVIGATRICE PALMARE 100X62X93MM

EXPERT

Per legno, metallo, vernice
Foglio divisibile con velcro



Art.	Formato	Grana	N°pezzi	EAN	
49496104	100x62x93mm	40	5	4009314961041	6
49496106	100x62x93mm	60	5	4009314961065	6
49496108	100x62x93mm	80	5	4009314961089	6
49496112	100x62x93mm	120	5	4009314961122	6
49496118	100x62x93mm	180	5	4009314961188	6
49496124	100x62x93mm	240	5	4009314961249	6
49496170	100x62x93mm	60-120-180	12	4009314961708	6



TRIANGOLI ABRASIVI PER LEVIGATRICE PALMARE 107X175MM

EXPERT

Per legno, metallo,
vernice con velcro



Art.	Formato	Grana	N°pezzi	EAN	
49493404	107x175mm	40	5	4009314934045	6
49493406	107x175mm	60	5	4009314934069	6
49493408	107x175mm	80	5	4009314934083	6
49493412	107x175mm	120	5	4009314934120	6
49493418	107x175mm	180	5	4009314934182	6
49493424	107x175mm	240	5	4009314934243	6



TRIANGOLI ABRASIVI PER LEVIGATRICE PALMARE 96X136MM

EXPERT

Per legno, metallo,
vernice con velcro



Art.	Formato	Grana	N°pezzi	EAN	
49493608	96 x 136mm	80	5	4009314936087	6
49493612	96 x 136mm	120	5	4009314936124	6
49493624	96 x 136mm	240	5	4009314936247	6



PER LEVIGATRICI ORBITALI DELTA

TRIANGOLI ABRASIVI 93X93MM - 5PZ.

EXPERT

Per legno, metallo,
vernice con velcro



Art.	Formato	Grana	N°pezzi	EAN	
49492804	93x93x93mm	40	5	4009314928044	6
49492806	93x93x93mm	60	5	4009314928068	6
49492808	93x93x93mm	80	5	4009314928082	6
49492812	93x93x93mm	120	5	4009314928129	6
49492818	93x93x93mm	180	5	4009314928181	6
49492824	93x93x93mm	240	5	4009314928242	6
49492800	93x93x93mm	40-120-240	5	4009314928006	6
49492870	93x93x93mm	40-120-180	20	4009314928709	5



PER LEVIGATRICI ROTORBITALI

DISCHI IN RETE ABRASIVA PER LEVIGATRICE ROTORBITALE CON VELCRO 150/125MM

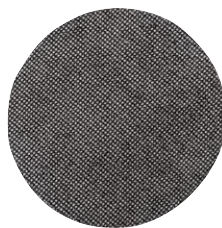

EXPERT

- Grana in carburo di silicio
- resistente all'acqua con velcro

*Dura fino a 4 volte in più della normale carta abrasiva
Si pulisce con aria compressa o acqua*

Art.	Formato	Grana	N°pezzi	EAN	
49491308	125mm	80	5		5
49491312	125mm	120	5		5
49491322	125mm	220	5		5
49491408	150mm	80	5		5
49491412	150mm	120	5		5
49491422	150mm	220	5		5



DISCHI ABRASIVI FORATI CON VELCRO PER LEVIGATRICE ROTORBITALE 150MM



EXPERT

*Per legno, metallo
e vernice con velcro*

Art.	Formato	Grana	N°pezzi	EAN	
49492004	150mm	40	5		6
49492006	150mm	60	5		6
49492008	150mm	80	5		6
49492012	150mm	120	5		6
49492018	150mm	180	5		6
49492024	150mm	240	5		6



DISCHI ABRASIVI FORATI CON VELCRO PER LEVIGATRICE ROTORBITALE 125MM



EXPERT

*Per legno, metallo
e vernice con velcro*

Art.	Formato	Grana	N°pezzi	EAN	
49491904	125mm	40	5		6
49491906	125mm	60	5		6
49491908	125mm	80	5		6
49491912	125mm	120	5		6
49491918	125mm	180	5		6
49491924	125mm	240	5		6
49491932	125mm	320	5		6
49541904	125mm	40	20		5
49541906	125mm	60	20		5
49541908	125mm	80	20		5
49541912	125mm	120	20		5
49541918	125mm	180	20		5
49541924	125mm	240	20		5
49491900	125mm	40-120-240	5		6
49491970	125mm	60-80-120	25		5



DISCHI ABRASIVI SENZA FORI CON VELCRO PER LEVIGATRICE ROTORBITALE 125MM

EXPERT

Per legno, metallo
e vernice con velcro



Art.	Ø	Grana	N°pezzi	EAN	
49488330	125 mm	40	5	40093142883305	6
49488320	125 mm	80	5	40093142883206	6
49488310	125 mm	120	5	40093142883107	6



DISCHI ABRASIVI SENZA FORI CON VELCRO PER LEVIGATRICE ROTORBITALE 115MM

EXPERT

Per legno, metallo
e vernice con velcro



Art.	Ø	Grana	N°pezzi	EAN	
49491804	115mm	40	5	40093142918045	5
49491806	115mm	60	5	40093142918069	5
49491808	115mm	80	5	40093142918083	5
49491812	115mm	120	5	40093142918120	5
49491818	115mm	180	5	40093142918182	5
49491824	115mm	240	5	40093142918244	5



PER LEVIGATRICI A NASTRO

NASTRI ABRASIVI 100 X 560MM

PROFESSIONAL

- Lunga durata
- Supporto in cotone

Per legno, metallo e vernice



Art.	Formato	Grana	N°pezzi	EAN	
49914404	100 x 560mm	40	3	40093191244043	3
49914410	100 x 560mm	100	3	40093191244104	3



NASTRI ABRASIVI 75 X 533MM

PROFESSIONAL

- Lunga durata
- Supporto in cotone

Per legno, metallo e vernice



Art.	Formato	Grana	N°pezzi	EAN	
49912504	75 x 533mm	40	3	4009319125042	3
49912506	75 x 533mm	60	3	4009319125066	3
49912508	75 x 533mm	80	3	4009319125080	3
49912510	75 x 533mm	100	3	4009319125103	3
49912512	75 x 533mm	120	3	4009319125127	3
49912515	75 x 533mm	150	3	4009319125158	3
49912524	75 x 533mm	240	3	4009319125240	3



Nastri Abrasivi 75 x 457mm

PROFESSIONAL

- Lunga durata
- Supporto in cotone



Per legno, metallo e vernice

Art.	Formato	Grana	N°pezzi	EAN	
49911904	75 x 457mm	40	3		3
49911906	75 x 457mm	60	3		3
49911908	75 x 457mm	80	3		3
49911910	75 x 457mm	100	3		3
49911912	75 x 457mm	120	3		3
49911915	75 x 457mm	150	3		3



Nastri Abrasivi 65 x 410mm

PROFESSIONAL

- Lunga durata
- Supporto in cotone

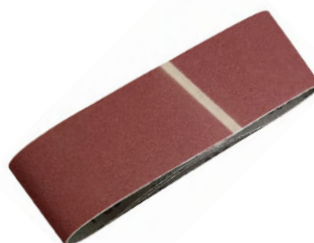

Per legno, metallo e vernice

Art.	Formato	Grana	N°pezzi	EAN	
49911404	65 x 410mm	40	3		3
49911408	65 x 410mm	80	3		3



Nastri Abrasivi 60 x 400mm

PROFESSIONAL

- Lunga durata
- Supporto in cotone

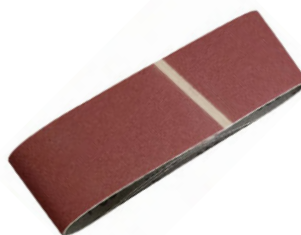

Per legno, metallo e vernice

Art.	Formato	Grana	N°pezzi	EAN	
49911006	60 x 400mm	60	3		3



Nastri Abrasivi per Lima a Nastro 13 x 457mm

PROFESSIONAL

- Lunga durata
- Supporto in cotone

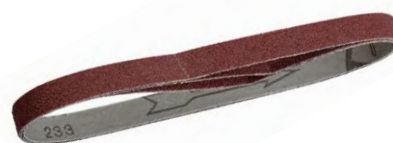

Per legno, metallo e vernice

Art.	Formato	Grana	N°pezzi	EAN	
49910504	13 x 457mm	40	3		3
49910506	13 x 457mm	60	3		3
49910510	13 x 457mm	100	3		3





PER LEVIGATRICI COMBinate

NASTRi ABRASIVI PER LEVIGATRICE COMBINATA 50X686MM

PROFESSIONAL

- Lunga durata
- Supporto in cotone

Per legno, metallo e vernice

Art.	Formato	Grana	N°pezzi	EAN	
49910805	50 x 686mm	60-80-120	5		1



NASTRi ABRASIVI PER LEVIGATRICE COMBINATA 100X914MM

PROFESSIONAL

- Lunga durata
- Supporto in cotone

Per legno, metallo e vernice

Art.	Formato	Grana	N°pezzi	EAN	
49914605	100 x 914mm	60-80-120	3		1



DISCHI ABRASIVI DI SUPPORTO PER LEVIGATRICE COMBINATA 150MM

PROFESSIONAL

- Per TC-US 400



Art.	Ø	Grana	N°pezzi	EAN	
49492074	150mm	80	3		1

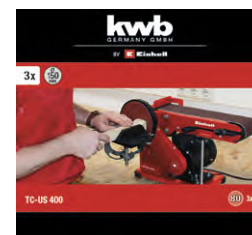





DISCHI IN FIBRA PER SMERIGLIATRICE

DISCHI ABRASIVI IN FIBRA DI ZIRCONIO PER SMERIGLIATRICE 115/125MM

EXPERT

Senza velcro



Art.	Ø	Grana	N°pezzi	EAN	
49714521	115mm	16	5		4
49714522	115mm	24	5		4
49714523	115mm	40	5		4
49714524	115mm	60	5		4
49714525	115mm	80	5		4
49714526	115mm	100	5		4
49714527	115mm	120	5		4
49714541	125mm	16	5		4
49714542	125mm	24	5		4
49714543	125mm	40	5		4
49714544	125mm	60	5		4
49714545	125mm	80	5		4
49714546	125mm	100	5		4
49714547	125mm	120	5		4

DISCHI ABRASIVI IN FIBRA DI CORINDONE PER SMERIGLIATRICE 115/125/180MM

CLASSIC

Senza velcro

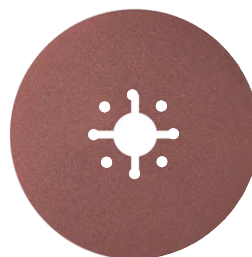

Art.	Ø	Grana	N°pezzi	EAN	
49714421	115mm	16	5	4009317144212	4
49714422	115mm	24	5	4009317144223	4
49714423	115mm	40	5	4009317144236	4
49714424	115mm	60	5	4009317144243	4
49714425	115mm	80	5	4009317144250	4
49714426	115mm	100	5	4009317144267	4
49714427	115mm	120	5	4009317144274	4
49714441	125mm	16	5	4009317144410	4
49714442	125mm	24	5	4009317144427	4
49714443	125mm	40	5	4009317144434	4
49714444	125mm	60	5	4009317144441	4
49714445	125mm	80	5	4009317144458	4
49714446	125mm	100	5	4009317144465	4
49714447	125mm	120	5	4009317144472	4
49714461	180mm	16	5	4009317144618	4
49714462	180mm	24	5	4009317144625	4
49714463	180mm	40	5	4009317144632	4
49714464	180mm	60	5	4009317144649	4
49714465	180mm	80	5	4009317144656	4
49714466	180mm	100	5	4009317144663	4
49714467	180mm	120	5	4009317144670	4

LEVIGATURA MANUALE

CEPPO PER LEVIGATURA MANUALE

PROFESSIONAL



Art.	Formato	EAN	
49485000	130 x 70 mm	4009312850000	6

LEVIGATRICE MANUALE PORTATILE

EXPERT

- Pratico e portatile
- Resistente
- Con clip di chiusura



Art.	Formato	EAN	
49485121	165 x 87 mm	4009312851212	10

CEPPO DI LEVIGATURA MANUALE IN SUGHERO

PROFESSIONAL



Art.	Formato	EAN	📦
49484800	40 x 60 x 100 mm	4009318200400	12
49484900	40 x 80 x 120 mm	4009318200404	12

PANNO SMERIGLIATO SINGOLO PER METALLO

PROFESSIONAL

- Tessuto di alta qualità
- Flessibile e resistente

*Per ruggine, vernice, lacca
metalfo, acciaio e bronzo
Uso a secco*



Art.	Formato	Grana	N°pezzi	EAN	📦
49820040	230 x 280mm	40	25	4009318200405	25
49820060	230 x 280mm	60	50	4009318200603	50
49820080	230 x 280mm	80	50	4009318200801	50
49820100	230 x 280mm	100	50	4009318201002	50
49820120	230 x 280mm	120	50	4009318201204	50
49820150	230 x 280mm	150	50	4009318201501	50
49820180	230 x 280mm	180	50	4009318201803	50
49820240	230 x 280mm	240	50	4009318202409	50



FOGLIO SINGOLO DI CARTA ABRASIVA IMPERMEABILE PER CARROZZERIA

PROFESSIONAL

- Resistente all'acqua

*Per metallo, lamiera, ruggine,
vernici, acciaio e carrozzeria auto
Uso con o senza acqua*



Art.	Formato	Grana	N°pezzi	EAN	📦
49830080	230 x 280mm	80	50	4009318300808	50
49830120	230 x 280mm	120	50	4009318301201	50
49830180	230 x 280mm	180	50	4009318301805	50
49830240	230 x 280mm	240	50	4009318302402	50
49830320	230 x 280mm	320	50	4009318303205	50
49830400	230 x 280mm	400	50	4009318304004	50
49830600	230 x 280mm	600	50	4009318306009	50
49830800	230 x 280mm	800	50	4009318308002	50
49830980	230 x 280mm	1000	50	4009318309801	50
49830990	230 x 280mm	1200	50	4009318309900	50



FOGLIO SINGOLO DI CARTA ABRASIVA PER LEGNO E METALLO

EXPERT

- Flessibile
- Corindone resistente di alta qualità

Per legno duro e tenero
Metallo, acciaio e vernice



Art.	Formato	Grana	N°pezzi	EAN	
49810040	230 x 280mm	40	50		50
49810060	230 x 280mm	60	50		50
49810080	230 x 280mm	80	50		50
49810100	230 x 280mm	100	50		50
49810120	230 x 280mm	120	50		50
49810150	230 x 280mm	150	50		50
49810180	230 x 280mm	180	50		50



FOGLIO SINGOLO DI CARTA ABRASIVA PER LEGNO E VERNICE

CLASSIC

Per legno, plastica
stucco e vernice

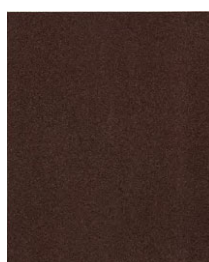

Art.	Formato	Grana	N°pezzi	EAN	
49800040	230 x 280mm	40	50		25
49800060	230 x 280mm	60	50		50
49800080	230 x 280mm	80	50		50
49800100	230 x 280mm	100	50		50
49800120	230 x 280mm	120	50		50
49800150	230 x 280mm	150	50		50
49800180	230 x 280mm	180	50		50
49800240	230 x 280mm	240	50		50



LANA D'ACCIAIO - 2PZ.

PROFESSIONAL



Art.	Tipo	Grana	EAN	
49089400	00	Fine		6
49089410	01	Media		6
49089430	03	Grossolana		6



LANA D'ACCIAIO

PROFESSIONAL



Per legno, metallo e vernice

Art.	Peso	Grana	EAN	
49089530	200g	Grossolana		12
49089510	200g	Media		12
49089500	200g	Fine		12
49089600	150g	Ultrafine		12



SPUGNA ABRASIVA PER LEGNO E METALLO

EXPERT



Per legno, metallo e vernice

Art.	Formato	Grana	EAN	
49089030	125 x 100 x 10 mm	60		6
49089020	125 x 100 x 10 mm	120		6
49089010	125 x 100 x 10 mm	180		6



SPUGNA ABRASIVA A 4 FACCE

EXPERT

- Poliuretano flessibile impermeabile



Per legno, metallo e vernice

Art.	Formato	Grana	EAN	
49089111	100 x 70mm	Fine		50
49089131	100 x 70mm	Grossa		50



ACCESSORI PER LUCIDATURA



CUFFIA PER LUCIDATURA QUICK-STICK IN VERA PELLE D'AGNELLO TESSUTA

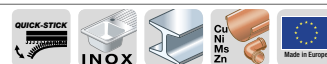

PROFESSIONAL

- Per lucidare ogni tipo di materiale

Per legno, metallo, inox, plastica, vetro, acrilico e vernice



Art.	Ø	EAN	📦
49485500	135 mm		6

CUFFIA PER LUCIDATURA CON VELCRO IN VERA PELLE D'AGNELLO 125 MM

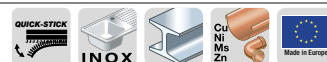



PROFESSIONAL

- Per lucidare ogni tipo di materiale

Per legno, metallo, inox, plastica, vetro, acrilico e vernice



Art.	Ø	EAN	📦
49484700	125mm		6
49484600	125mm		6

CUFFIA PER LUCIDATURA

EXPERT

- Per lucidare ogni tipo di materiale

*ideale per uso con platorello
49483500*



Art.	Ø	EAN	
49484500	135 mm		6

DISCO LAMELLARE PER LUCIDATURA

PROFESSIONAL

- Lucidatura del metallo
- Utilizzo frontale
- Lamelle in feltro
- raccomandato per utilizzo a basse velocità

*Per metalli, Inox
e alluminio*



Art.	Ø	Grana	Giri max./min.	EAN	
49486200	115mm	22,23mm	8.350		10

TAMPONE IN FELTRO PER LUCIDATURA 125MM

PROFESSIONAL

- Per lucidare ogni tipo di materiale

*Per legno, metallo, inox,
plastica, vetro, acrilico e vernice*



Art.	Ø	EAN	
49486000	125mm		6

TAMPONE IN FELTRO TRIANGOLARE PER LUCIDATURA

PROFESSIONAL

- Per lucidare ogni tipo di materiale

*Per legno, metallo, inox,
plastica, vetro, acrilico e vernice*



Art.	Ø	EAN	
49493000	93x93x93mm		6

TAMPONE DI SPUGNA QUICK-STICK 125MM

PROFESSIONAL

- Per lucidare ogni tipo di materiale



Art.	Ø	EAN	
49486600	125 mm		5

DISCO PER LUCIDATURA IN FELTRO

EXPERT



Art.	Ø	Ø alloggiamento	Spessore	EAN	Imb.
49511300	75mm	13mm	12mm		6

DISCO PER LUCIDATURA IN PANNO

EXPERT



Art.	Ø	Ø alloggiamento	Spessore	EAN	Imb.
49517300	75mm	13mm	10mm		6
49517400	100mm	13mm	10mm		6

TAMPONE DI SPUGNA CON CODOLO PER TRAPANO 120MM

PROFESSIONAL

- Per lucidare ogni tipo di materiale



Art.	Ø	Ø codolo	EAN	Imb.
49486700	120mm	8mm		5

SET DI 2 PASTE ABRASIVE PER LUCIDATURA

PROFESSIONAL

Per legno, metallo, inox, plastica, vetro, acrilico e vernice



Art.	N°pezzi	EAN	Imb.
49485420	2		5

SET PER LUCIDATURA - 6PZ.

EXPERT

- Incluse 2 paste abrasive e due dischi per lucidatura per uso con trapano



Per legno, metallo, inox, plastica, vetro, acrilico e vernice

Art.	N°pezzi	EAN	
49485300	6	4009344853001	3



SET PER LUCIDATURA - 5PZ.

EXPERT

- Incluse 2 paste abrasive e due dischi per lucidatura per uso con trapano

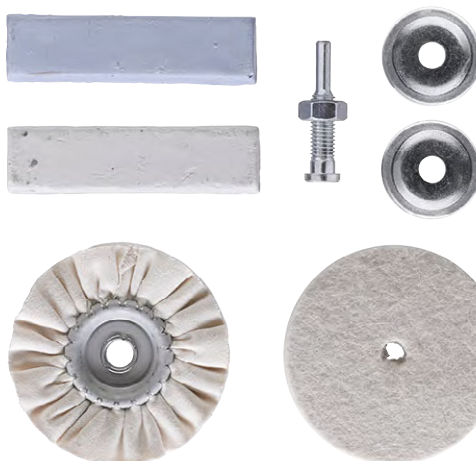

Per legno, metallo, inox, plastica, vetro, acrilico e vernice

Art.	N°pezzi	EAN	
49485200	5	4009344852004	3



MANDRINO DI SERRAGGIO PER LUCIDATRICE

EXPERT

- Lucidatrice 34 x 10mm



Art.	N°pezzi	EAN	
49501000	4	4009345010007	6

SPAZZOLE



SPAZZOLE IN FILO D'ACCIAIO

SPAZZOLA A DISCO PIANO IN FILO D'ACCIAIO INTRECCIATO HSS DA 0,50MM



PROFESSIONAL

- Pulizia profonda
- Incrostazioni profonde
- Rimozione rivestimenti
- Per uso con smerigliatrice angolare



Art.	Ø	Tipo	Attacco	EAN	📦
49719730	115mm	Piano	M14	400951197300	3

SPAZZOLA A DISCO PIANO IN FILO D'ACCIAIO INTRECCIATO HSS DA 0,50MM

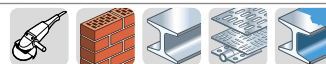

PROFESSIONAL

- Pulizia profonda
- Incrostazioni profonde
- Rimozione rivestimenti
- Per uso con smerigliatrice angolare



Art.	Ø	Tipo	Attacco	EAN	📦
49719330	100mm	Conico	M14	400951193300	3

SPAZZOLA A TAZZA CON FILO D'ACCIAIO INTRECCIATO HSS



PROFESSIONAL

- Pulizia profonda
- Incrostazioni profonde
- Rimozione rivestimenti
- Per uso con smerigliatrice angolare



Art.	Ø	Ø filo	Attacco	EAN	6
49719206	66mm	0,5mm	M14		6

SPAZZOLA A TAZZA IN FILO D'ACCIAIO ONDULATO HSS



PROFESSIONAL

- Pulizia profonda
- Incrostazioni profonde
- Rimozione rivestimenti
- Per uso con smerigliatrice angolare



Art.	Ø	Ø filo	Attacco	EAN	6
49719106	60mm	0,3mm	M14		6
49719110	100mm	0,3mm	M14		4

SPAZZOLA A DISCO FILO D'ACCIAIO INTRECCIATO HSS EXTRAFORTE



PROFESSIONAL

- Pulizia profonda
- Incrostazioni profonde
- Rimozione rivestimenti
- Per uso con trapano
- Codolo esagonale



Art.	Ø	Ø filo	Attacco	EAN	6
49603030	70mm	0,5mm	Hex E 6.3		6

SPAZZOLA A TAZZA PESANTE IN FILO IN ACCIAIO ONDULATO HSS



PROFESSIONAL

- Pulizia profonda
- Rimozione ruggine
- Sbavatura dei metalli
- Per uso con trapano
- Codolo esagonale

Per pulizia di ruggine, metallo, mattoni e pietra



Art.	Ø	Ø filo	Attacco	EAN	6
49602430	80mm	0,35mm	Hex E 6.3		6

SPAZZOLA A TAZZA IN FILO D'ACCIAIO ONDULATO HSS

PROFESSIONAL

- Pulizia di casseforme e facciate
- Rimozione della ruggine
- Per uso con trapano
- Codolo esagonale

Per metallo e ruggine



Art.	Ø	Ø filo	Attacco	EAN	📦
49606210	50mm	0,2mm	Hex E 6.3		6
49606330	75mm	0,3mm	Hex E 6.3		6
49606310	75mm	0,2mm	Hex E 6.3		6

SPAZZOLA A DISCO IN FILO D'ACCIAIO ONDULATO HSS

PROFESSIONAL

- Pulizia aggressiva
- Ideale per i bordi più stretti
- Per uso con trapano
- Codolo esagonale

Per metallo e ruggine



Art.	Ø	Ø filo	Attacco	EAN	📦
49607130	38mm	0,2mm	Hex E 6.3		6
49607310	75mm	0,2mm	Hex E 6.3		6
49607830	75mm	0,3mm	Hex E 6.3		6
49607930	100mm	0,3mm	Hex E 6.3		6
49607430	100mm	0,35mm	Hex E 6.3		6

SPAZZOLA A PENNELLO IN FILO D'ACCIAIO ONDULATO HSS

PROFESSIONAL

- Pulisce anche nei posti meno accessibili
- Rimozione ruggine
- Per uso con trapano
- Codolo esagonale

Per ruggine, metallo, mattoni e pietra



Art.	Ø	Ø filo	Attacco	EAN	📦
49608030	25mm	0,3mm	Hex E 6.3		6

SPAZZOLA ELICOIDALE PER TUBI IN FILO D'ACCIAIO ONDULATO HSS

EXPERT

- Lunghezza totale 200mm
- Per uso con trapano
- Codolo cilindrico 8mm

Per tubi metallici



Art.	Ø	Ø filo	Lunghezza spazzola	EAN	📦
49599300	20 mm	0,2mm	55 mm		6
49599400	26 mm	0,2mm	55 mm		6
49599500	32 mm	0,2mm	55 mm		6
49599600	38 mm	0,2mm	55 mm		6

SET DI SPAZZOLE IN FILO D'ACCIAIO A CODOLO ESAGONALE - 4PZ.

EXPERT

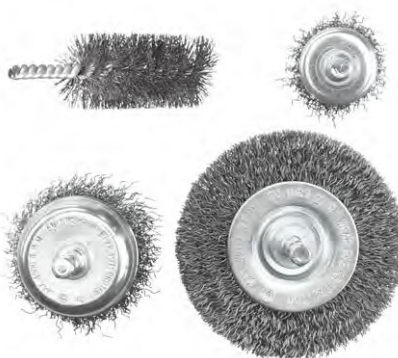

Art.	Ø	Ø filo	Attacco	EAN	📦
49597530	25, 50,75mm	0,3mm	Hex E 6.3		4

SPAZZOLE IN FILO D'OTTONE

SPAZZOLA A TAZZA IN FILO D'OTTONE ONDULATO

PROFESSIONAL

- Protezione anti-corrosione
- Pulizia delicata
- Rimozione vernice
- Per uso con trapano
- Codolo esagonale

Per ruggine, vernice, metallo e legno



Art.	Ø	Ø filo	Attacco	EAN	📦
49609110	50mm	0,27mm	Hex E 6.3		6

SPAZZOLA A DISCO IN FILO D'OTTONE ONDULATO

PROFESSIONAL

- Protezione anti-corrosione
- Pulizia delicata
- Rimozione vernice
- Per uso con trapano
- Codolo esagonale

Per ruggine, metallo, legno e vernice



Art.	Ø	Ø filo	Attacco	EAN	📦
49609310	75mm	0,2mm	Hex E 6.3		6

SPAZZOLA A DOPPIO FILO IN OTTONE ONDULATO

PROFESSIONAL

- Protezione anti-corrosione
- Pulizia delicata
- Rimozione vernice
- Per uso con trapano
- Codolo esagonale

Per legno e vernice



Art.	Ø	Ø filo	Attacco	EAN	📦
49604030	80mm	0,27mm	Hex E 6.3		6

SPAZZOLE IN FILO DI NYLON

SPAZZOLA A TAZZA IN NYLON ABRASIVO

PROFESSIONAL

- Pulizia delicata
- Per uso con trapano
- Codolo esagonale

*Per legno, metallo,
vernice e inox*



Art.	Ø	Ø filo	Attacco	EAN	📦
49603230	50mm	0,1mm	Hex E 6.3		6
49603330	75mm	0,1mm	Hex E 6.3		6

SPAZZOLA A DISCO IN NYLON ABRASIVO

PROFESSIONAL

- Pulizia delicata
- Per uso con trapano
- Codolo esagonale

*Per legno, metallo,
vernice e inox*



Art.	Ø	Ø filo	Attacco	EAN	📦
49604310	75mm	0,9mm	Hex E 6.3		6
49604330	75mm	1,0mm	Hex E 6.3		6
49604430	100mm	1,0mm	Hex E 6.3		6

SPAZZOLA A PENNELLO IN NYLON FINE

PROFESSIONAL

- Pulizia delicata
- Per uso con trapano
- Codolo esagonale

*Per legno, metallo,
vernice e inox*



Art.	Ø	Ø filo	Attacco	EAN	📦
49605030	22mm	1,0mm	Hex E 6.3		6

SPAZZOLE MANUALI

SPAZZOLA MANUALE 4 FILI IN OTTONE

PROFESSIONAL

- Pulizia aggressiva
- Rimozione ruggine



Art.	Materiale	Lunghezza totale	Larghezza	EAN	📦
49922740	Ottone	275mm	35mm		12

SPAZZOLA MANUALE IN FILO D'ACCIAIO

PROFESSIONAL

- Pulizia profonda
- Rimozione ruggine



Art.	Materiale	Lunghezza totale	Larghezza	EAN	📦
49923211	Acciaio	290mm	35mm		24

SPAZZOLE SFUSE IN BOX

SPAZZOLA A TAZZA IN FILO D'ACCIAIO INTRECCIATO HSS - BOX 10PZ.



PROFESSIONAL

- Pulizia profonda
- Incrostazioni profonde
- Rimozione rivestimenti
- Per uso con smerigliatrice angolare



Art.	Ø	Ø filo	Attacco	EAN	📦
49719236	66mm	0,5mm	M14		10

SPAZZOLA A TAZZA M14 IN FILO D'ACCIAIO ONDULATO HSS - BOX



PROFESSIONAL

- Pulizia profonda
- Incrostazioni profonde
- Rimozione rivestimenti
- Per uso con smerigliatrice angolare

Per ruggine, vernice, metallo e legno



Art.	Ø	Ø filo	Attacco	EAN	📦
49719126	100mm	0,3mm	M14		8
49719136	60mm	0,3mm	M14		16

SPAZZOLA A TAZZA IN FILO D'ACCIAIO ONDULATO HSS - BOX



PROFESSIONAL

- Pulizia di casseforme e facciate
- Rimozione della ruggine
- Per uso con trapano
- Codolo esagonale

Per metallo e ruggine



Art.	Ø	Ø filo	Attacco	EAN	📦
49606233	50mm	0,2mm	Hex E 6.3		25
49606333	75mm	0,3mm	Hex E 6.3		15

SPAZZOLA A DISCO IN FILO D'ACCIAIO ONDULATO HSS - BOX



PROFESSIONAL

- Pulizia aggressiva
- Ideale per i bordi più stretti
- Lavorazione su bordi
- Per uso con trapano
- Codolo esagonale

*Per metallo
e ruggine*



Art.	Ø	Ø filo	Attacco	EAN	📦
49607333	75mm	0,3mm	Hex E 6.3		25
49607433	100mm	0,3mm	Hex E 6.3		15
49607833	75mm	0,3mm	Hex E 6.3		20
49607933	100mm	0,3mm	Hex E 6.3		10

SPAZZOLA A PENNELLO IN FILO D'ACCIAIO ONDULATO HSS - BOX 24PZ.



PROFESSIONAL

- Pulisce anche nei posti meno accessibili
- Rimozione ruggine
- Per uso con trapano
- Codolo esagonale

*Per ruggine, metallo,
mattoni e pietra*



Art.	Ø	Ø filo	Attacco	EAN	📦
49608033	25mm	0,3mm	Hex E 6.3		24

SPAZZOLA A TAZZA IN FILO D'OTTONE DA 0,27 MM - BOX 25PZ.



PROFESSIONAL

- Protezione anti-corrosione
- Pulizia delicata
- Rimozione vernice
- Per uso con trapano
- Codolo esagonale

*Per ruggine, vernice,
metallo e legno*



Art.	Ø	Ø filo	Attacco	EAN	📦
49609113	50mm	0,27mm	Hex E 6.3		25

SPAZZOLA A DISCO IN FILO D'OTTONE DA 0,2 MM - BOX 25PZ.



PROFESSIONAL

- Protezione anti-corrosione
- Pulizia delicata
- Rimozione vernice
- Per uso con trapano
- Codolo esagonale

*Per ruggine, metallo,
legno e vernice*



Art.	Ø	Ø filo	Attacco	EAN	
49609313	75mm	0,2mm	Hex E 6.3		25

SPAZZOLA DOPPIO FILO IN OTTONE DA 0,27 MM - BOX 10PZ.



PROFESSIONAL

- Protezione anti-corrosione
- Pulizia delicata
- Rimozione vernice
- Per uso con trapano
- Codolo esagonale

Per legno e vernice



Art.	Ø	Ø filo	Attacco	EAN	
49604033	80mm	0,27mm	Hex E 6.3		10



FRESE, MOLE E RASPE ROTATIVE



ALBERO PER SMERIGLIATRICE A STELO

Art.	Contenuto	Lunghezza	EAN	
49522300	Albero flessibile	950mm		1



FRESE ROTATIVE









FRESA DRITTA IN METALLO DURO PER LEGNO CODOLO CILINDRICO

HM

EXPERT

- Due taglienti
- Per scanalature
- Per legno e pannelli



Art.	Ø	Lung. tagliente	Ø codolo	EAN	
49754620	6mm	20mm	8mm		4
49754820	8mm	20mm	8mm		4
49754420	10mm	20mm	8mm		4
49754520	12mm	20mm	8mm		4
49754720	14mm	20mm	8mm		4
49754920	16mm	20mm	8mm		4
49754320	18mm	20mm	8mm		4
49755020	20mm	20mm	8mm		4



FRESE, MOLE E RASPE ROTATIVE

FRESA TONDA IN METALLO DURO PER LEGNO CODOLO CILINDRICO



EXPERT

- Due taglienti
- Per profilatura tonda
- Per legno e pannelli



Art.	Ø	Raggio	Ø codolo	EAN	📦
49756620	25,7mm	6,35mm	8mm		4

FRESA TONDA CON ANGOLI IN METALLO DURO PER LEGNO CODOLO CILINDRICO



EXPERT

- Due taglienti
- Per profilatura tonda con angoli
- Per legno e pannelli



Art.	Ø	Raggio	Ø codolo	EAN	📦
49756320	25,4mm	6,35mm	8mm		4

FRESA DRITTA IN METALLO DURO PER ANGOLI PER LEGNO CODOLO CILINDRICO



EXPERT

- Due taglienti
- Per angoli
- Per legno e pannelli



Art.	Ø	Altezza tagliente	Ø codolo	EAN	📦
49756220	31,7mm	13,5mm	8mm		4

FRESA DRITTA IN METALLO DURO PER SCANALATURA SOTTILE CODOLO CILINDRICO



EXPERT

- Due taglienti
- Per profilatura tonda
- Per legno e pannelli



Art.	Altezza tagliente	Ø codolo	EAN	📦
49754030	3,0mm	8mm		4

FRESA DRITTA IN METALLO DURO PER SCANALATURE TONDE PER LEGNO CODOLO CILINDRICO



EXPERT

- Due taglienti
- Per scanalatura tonda
- Per legno e pannelli



Art.	Ø	Raggio	Ø codolo	EAN	
49755820	12,7mm	9,4mm	8mm		4

FRESA DRITTA IN METALLO DURO PER SCANALATURA A T PER LEGNO CODOLO CILINDRICO



EXPERT

- Due taglienti
- Per scanalature a T
- Per legno e pannelli

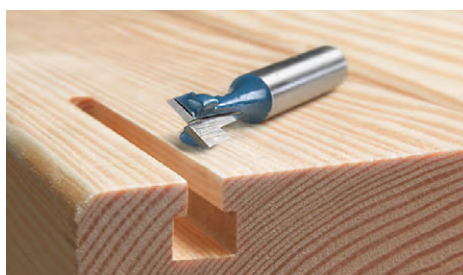

Art.	Larghezza 1	Larghezza 2	Ø codolo	EAN	
49755520	5,0mm	9,5mm	8mm		4

FRESA A FRECCIA IN METALLO DURO CODOLO CILINDRICO



EXPERT

- Per incidere
- Per legno e pannelli



Art.	Ø	Angolo	Ø codolo	EAN	
49755720	8mm	90°	8mm		4

FRESA DRITTA IN METALLO DURO PER SCANALATURA A V CODOLO CILINDRICO



EXPERT

- Due taglienti
- Per scanalatura a V
- Per legno e pannelli

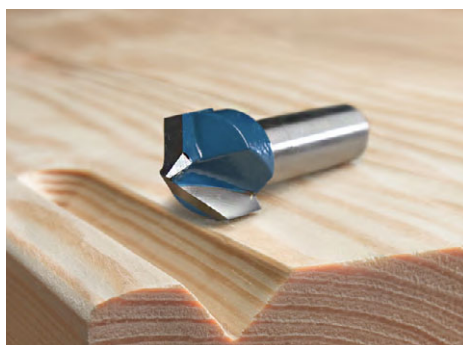

Art.	Ø	Angolo	Ø codolo	EAN	
49755120	14,0mm	90°	8mm		4

SET DI FRESE IN METALLO DURO ASSORTITE - 12PZ.

CLASSIC

- Due taglienti
- Assortimento completo
- Codolo 8 mm

Per legno duro e tenero



Art.	N°pezzi	Ø codolo	EAN	📦
49757290	12	8mm		1

SET DI FRESE IN METALLO DURO ASSORTITE - 12PZ.

CLASSIC

- Due taglienti
- Assortimento completo
- Codolo 8 mm

Per legno duro e tenero



Art.	N°pezzi	Ø codolo	EAN	📦
49757291	15	8mm		1

FRESA ROTATIVA PER METALLO TESTA CILINDRICA



EXPERT

- Fresatura ruggine
- Sbavatura metallo



Art.	Ø	Lunghezza tagliente	Ø codolo	EAN	
49700140	13mm	32mm	6mm		3

FRESA ROTATIVA PER METALLO TESTA CILINDRICA SMUSSATA



EXPERT

- Fresatura ruggine
- Sbavatura metallo



Art.	Ø	Lunghezza tagliente	Ø codolo	EAN	
49700740	13mm	32mm	6mm		3

FRESA ROTATIVA PER METALLO TESTA OGIVALE



EXPERT

- Fresatura ruggine
- Sbavatura metallo



Art.	Ø	Lunghezza tagliente	Ø codolo	EAN	
49700340	13mm	32mm	6mm		3

FRESA ROTATIVA PER METALLO TESTA CONICA



EXPERT

- Fresatura ruggine
- Sbavatura metallo



Art.	Ø	Lunghezza tagliente	Ø codolo	EAN	
49700840	13mm	32mm	6mm		3

FRESA ROTATIVA PER METALLO TESTA SFERICA



EXPERT

- Fresatura ruggine
- Sbavatura metallo



Art.	Ø	Lunghezza tagliente	Ø codolo	EAN	
49700540	12mm	12mm	6mm		3

MOLE ROTATIVE

MOLE ABRASIVA CILINDRICA

EXPERT

- Corindone
- Per alesatura bave
- Max. 23 000 RPM



Art.	Ø	Altezza mola	Ø codolo	EAN	6
49553000	16mm	30mm	6mm	4009315530000	6
49551000	25mm	25mm	6mm	4009315510002	6

MOLE ABRASIVA CONICA

EXPERT

- Corindone
- Per alesatura bave
- Max. 23 000 RPM



Art.	Ø	Altezza mola	Ø codolo	EAN	6
49551700	25mm	30mm	6mm	4009315517001	6
49552300	30mm	30mm	6mm	4009315523002	6

MOLE ABRASIVA A DISCO

EXPERT

- Corindone
- Per alesatura bave
- Max. 23 000 RPM



Art.	Ø	Altezza mola	Ø codolo	EAN	6
49555000	40mm	10mm	6mm	4009315550008	6

MOLE ABRASIVA OGIVALE

EXPERT

- Corindone
- Per alesatura bave
- Max. 23 000 RPM



Art.	Ø	Altezza mola	Ø codolo	EAN	6
49553300	16mm	30mm	6mm	4009315533001	6

MOLE A CONO ARROTONDATO

EXPERT

- Corindone
- Per alesatura bave
- Max. 23 000 RPM



Art.	Ø	Altezza mola	Ø codolo	EAN	6
49551400	25mm	30mm	6mm	4009315514000	6

SET DI MOLE ABRASIVE CERAMICHE - 5PZ.



EXPERT

- Corindone
- Assortimento completo
- Max. 23 000 RPM



Art.	N°pezzi	Ø codolo	EAN	
49510000	5	6mm		6



SET DI MOLE ABRASIVE CERAMICHE - 5PZ.



EXPERT

- Corindone
- Assortimento completo
- Max. 23 000 RPM



Art.	N°pezzi	Ø codolo	EAN	
49510100	5	6mm		6



SET DI MINI ACCESSORI PER SMERIGLIATRICE A STELO - 105PZ.



CLASSIC

- Assortimento completo per restauro di miniature



Art.	N°pezzi	Ø codolo	EAN	
49510900	105	3mm		1



MOLA PER AFFILATURA COLTELLI E FORBICI

CLASSIC

- Corindone azzurro



Art.	Ø	Ø codolo	EAN	
49493800	49mm	6mm		6

SEGA AD ARCO PER LEGNO

EXPERT

- Scanalature profonde



Art.	Ø	Spessore	Ø codolo	EAN	
49557000	45mm	0,8mm	6mm		6

RASPE ROTATIVE

RASPA PER LEGNO A LAMPADINA

EXPERT



Art.	Ø	Lunghezza	Ø codolo	EAN	
49494300	16mm	30mm	6mm		6

RASPA PER LEGNO CILINDRICA

EXPERT



Art.	Ø	Lunghezza	Ø codolo	EAN	
49494500	16mm	30mm	6mm		6

RASPA PER LEGNO SEMITONDA

EXPERT



Art.	Ø	Lunghezza	Ø codolo	EAN	
49494600	13mm	35mm	6mm		6

RASPA PER LEGNO CONICA

EXPERT



Art.	Ø min-max	Altezza	Ø codolo	EAN	
49494700	7-15mm	35mm	6mm		6

RASPA PER LEGNO SFERICA

EXPERT



Art.	Ø	Ø codolo	EAN	
49494800	16mm	6mm		6

RASPA PER METALLO CILINDRICA

EXPERT

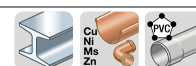

Art.	Ø	Lunghezza	Ø codolo	EAN	
49494900	15mm	30mm	6mm		6

RASPA PER METALLO CONICA

EXPERT



Art.	Ø min-max	Lunghezza	Ø codolo	EAN	
49495000	7-15mm	35mm	6mm		6

SET DI RASPE PER LEGNO E METALLO - 6PZ.

EXPERT

- Per la creazione di forme diverse nel materiale

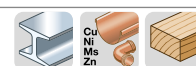

Art.	N°pezzi	Ø codolo	EAN	
49495500	6	6mm		1

MOLE ABRASIVE LAMELLARI

MOLA ABRASIVA LAMELLARE IN CORINDONE

PROFESSIONAL

■ Incollaggio forte

Codolo Ø 6mm



Art.	Ø	Altezza	Grana	EAN	📦
49088110	50mm	20mm	120		6
49088130	50mm	20mm	60		6
49088030	60mm	40mm	60		6



MOLA ABRASIVA LAMELLARE IN VELLO

PROFESSIONAL

■ Incollaggio forte

Codolo Ø 6mm

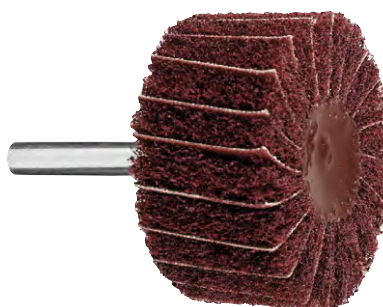

Art.	Ø	Altezza	Grana	EAN	📦
49088310	50mm	25mm	150		2
49088330	50mm	25mm	60		2



FRUSTE PER MISCELATORI







FRUSTE PER VERNICE E COLORE A CODOLO ESAGONALE

CLASSIC

- Elevata stabilità

Per vernice e malta cementizia magra
Utilizzo con trapani con
potenza minima di 500W
Codolo esagonale 8mm



Art.	Ø	Lung. totale	Capacità	EAN	📦
49497191	60mm	400mm	5 L		6
49497391	80mm	400mm	15 L		3
49497005	80mm	400mm	40 L		1
49497591	100mm	600mm	25 L		3
49497215	100mm	600mm	40 L		1



FRUSTE PER MALTA A CODOLO ESAGONALE

EXPERT

- Elevata stabilità

Per vernice e malta cementizia magra
Utilizzo con trapani con
potenza minima di 500W
Codolo esagonale 8mm



Art.	Ø	Lung. totale	Capacità	EAN	📦
49497615	90mm	600mm	60 L		1



FRUSTE PER MISCELATORI



FRUSTE PER MALTA A CODOLO FILETTATO M14

CLASSIC

- Elevata stabilità

*Per vernice e malta cementizia
Utilizzo con trapani con
potenza minima di 500W
codolo con filettatura M14*



Art.	Ø	Lung. totale	Capacità	EAN	
49497635	120mm	600mm	80 L		1
49497625	120mm	600mm	80 L		1



COPPIA DI FRUSTE PER MALTA PER MISCELATORE DOPPIO CODOLO ESAGONALE

PROFESSIONAL

*Per vernice, colla, malta e cemento
Codolo esagonale 8mm*



Art.	Ø	Lung. totale	Capacità	EAN	
49497795	120mm	550mm	140L		1



ACCESSORI PER TRAPANO

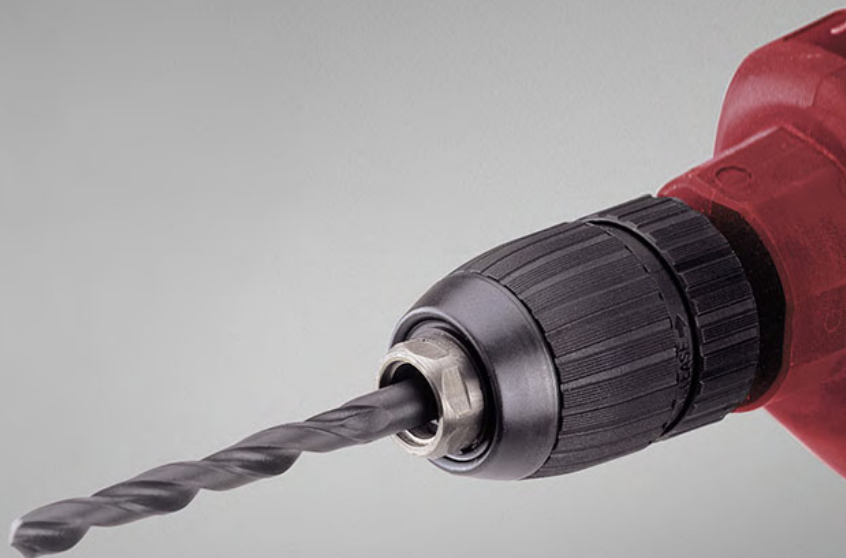

MANDRINI



MANDRINO A SERRAGGIO RAPIDO

PROFESSIONAL

- Aggancio/sgancio rapido

*Per tutte le punte più comuni
e tutti i tipi di materiale*



Art.	Uscita	Filettatura attacco	EAN	📦
49298171	1,0 -10mm	3/8" x 24mm		2
49298472	1,5 -13mm	1/2" x 20mm		2

MANDRINO A SERRAGGIO RAPIDO CON ADATTATORE SDS PLUS

CLASSIC

- Aggancio/sgancio rapido
- Inserzione 1/2" x 20
- Stelo SDS Plus

*Per tutte le punte più comuni
e tutti i tipi di materiale*



Art.	Uscita	Filettatura attacco	EAN	📦
49298490	1,5 -13mm	1/2" x 20mm		5



MANDRINO A CREMAGLIERA MANUALE

EXPERT

- Carcassa metallica
- Inserzione 1/2" x 20
- Sgancio manuale

*Per tutte le punte più comuni
e tutti i tipi di materiale*



Art.	Uscita	Filettatura attacco	EAN	📦
49291379	1,5 -13mm	1/2" x 20mm		2
49291078	1,5 -10mm	3/8" x 24mm		2

MANDRINO A CREMAGLIERA MANUALE CON ADATTATORE SDS PLUS



CLASSIC

- Stelo SDS Plus
- Inserzione 1/2" x 20
- Sgancio manuale

Per tutte le punte più comuni e tutti i tipi di materiale



Art.	Uscita	Filettatura attacco	EAN	
49291390	1,5 -13mm	1/2" x 20mm		5

MANDRINO DA 0,5 A 6,5 MM



EXPERT

- Aggancio/sgancio rapido
- Attacco esagonale

Per le punte più piccole per tutti i tipi di materiale

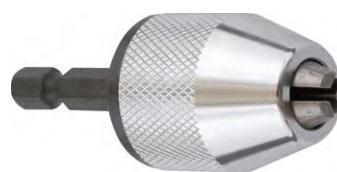

Art.	Uscita	Attacco	EAN	
49292500	0,5 - 6,5mm	Hex 1/4"		2

EXPERT

ADATTATORE SDS PLUS



Art.	Uscita	Attacco	EAN	
49299900	SDS Plus	1/2" x 20mm		5

CHIAVE PER MANDRINO A CREMAGLIERA

EXPERT

- Chiave S2 per diversi tipi di mandrino



Art.	Lunghezza	EAN	
49285920	100mm		10
49285820	150mm		10

PLATORELLI

PLATORELLO CON VELCRO PER TRAPANO

PROFESSIONAL

- In gomma elastica
- Stelo per trapano
- Per dischi con velcro



Art.	Ø	Ø codolo	EAN	
49487000	115mm	8mm		6
49488000	125mm	8mm		6

PLATORELLO IN GOMMA PER TRAPANO

EXPERT

- In gomma elastica
- Stelo per trapano



Art.	Ø	Ø codolo	EAN	
49483500	125mm	6mm		6

ALTRO

DISPOSITIVO RACCOGLI POLVERE

CLASSIC

- Tappetino circolare *Per cemento, mattoni e pietra*
- Recipiente ampio *Per punte e corone da 4-10 mm*



Art.	Ø	EAN	
49045400	4-10mm		6

ARRESTO DI PROFONDITÀ PER PUNTE DA TRAPANO

EXPERT

- Preforato per tasselli *Per legno, pannelli, melamina*



Art.	Ø	EAN	
49530300	6 - 8 - 10mm		10

ACCESSORI PER SMERIGLIATRICE ANGOLARE





GHIERE DI SERRAGGIO

GHIERA DI SERRAGGIO RAPIDO PER SMERIGLIATRICE

PROFESSIONAL

- Ideale per AXXIO
- Robusta e sicura
- Uso senza chiave



Art.	Ø filettatura	Ø disco	Interasse fori	EAN	
49717700	M14	115-230mm	-		4

GHIERA DI SERRAGGIO PER SMERIGLIATRICE

PROFESSIONAL

- Universale
- Per tutti i brand
- Per uso con chiave



Art.	Ø filettatura	Ø disco	Interasse fori	EAN	
49717600	M14	115-230mm	35x5,8 / 30x4,8mm		5

GHIERA DI SERRAGGIO CONICA PER SMERIGLIATRICE

PROFESSIONAL

- Robusta e sicura
- Per tutti i brand
- Per uso con chiave



Art.	Ø filettatura	Ø disco	Interasse fori	EAN	
49486200	M14	115-230mm	35x5,8 / 30x4,8mm		2

CHIAVI PER SERRAGGIO

CHIAVE A DUE FORI PER SMERIGLIATRICE

PROFESSIONAL

- DIN 3116



Art.	Ø perno	Distanza perni	EAN	📦
49718210	4mm	30mm		2
49718310	5mm	35mm		2

CHIAVE A DUE FORI PER SMERIGLIATRICE CON GHIERA

PROFESSIONAL

- Set completo
- DIN 3116

Ghiera con fori da 30 e 35 mm

Chiave da 35 x 5 mm



Art.	Ø perno	Distanza perni	EAN	📦
49718500	5mm	35mm		2

CHIAVE A DUE FORI PER SMERIGLIATRICE CENTRO DEPRESSO

PROFESSIONAL



Art.	Ø perno	Distanza perni	EAN	📦
49718610	5mm	35mm		25

CHIAVE A FORCELLA PIATTA PER SMERIGLIATRICE

PROFESSIONAL



Art.	Tipo	Apertura	EAN	📦
49717500	Piatta	17mm		5

PLATORELLI

PLATORELLO ELASTICO IN GOMMA PER SMERIGLIATRICE

PROFESSIONAL

- Elastico



Art.	Ø	Ø filettatura	EAN	📦
49718111	115mm	M14		5
49718112	125mm	M14		5

PLATORELLO VELCRATO PER SMERIGLIATRICE

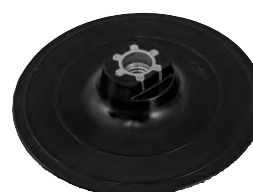

Art.	Ø	Ø filettatura	EAN	📦
49487014	115mm	M14		6
49488014	125mm	M14		6

SUPPORTI PER ELETTROUTENSILI



SUPPORTO PER TRAPANI PROFESSIONALE 43 MM A 90° E 45°

EXPERT

- Altezza 500 mm
- Ruotabile a 360°



Adatto a trapani con collo Ø 43 mm, con molla di fissaggio
regolazione profondità foro con scala millimetrata
Base 175 x 210 mm con attacchi per morsa

Art.	Ø	Angolo	EAN	📦
49777800	43mm	360°		1



SUPPORTO PER TRAPANI 43 MM A 90° E 45°

EXPERT

- Foratura orizzontale e angolare 45° o 90°
- Scanalatura V per fissaggio
- Regolazione di profondità

Adatto a trapani con collo Ø 43 mm



Art.	Ø	Angolo	EAN	
49778400	80mm	0-65mm		1

MORSA PER A CREAZIONE DI ANGOLI A 90°

PROFESSIONAL



Art.	Ampiezza serraggio	EAN	
49983300	60/47mm		1

MORSA DI BLOCCAGGIO

PROFESSIONAL

- Manovella metallica

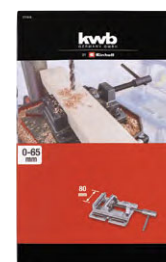
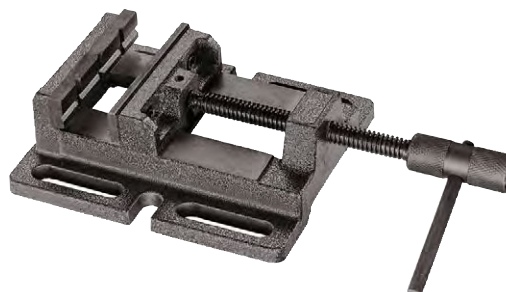

Art.	Lunghezza	Ampiezza serraggio	EAN	
49777015	80mm	0-65mm		1

CAVALLETTO DI SUPPORTO A RULLI PIEGHEVOLE



Art.	Peso massimo	EAN	
49785910	60kg		1



UTENSILI MANUALI

VALIGETTE

SET DI 70 PEZZI CON VALIGETTA



CONTENUTO:

- 1 x Pinze da taglio 160mm
- 1 x Pinza combinata 160mm
- 1 x Pinza a becco di pappagallo 200mm
- 1 x Chive inglese 0-22mm
- 1 x Cacciavite PH2 x 100mm (CV)
- 1 x Cacciavite piatto 6 x 100mm (CV)
- 1 x Mini Cacciavite PH2 x 38mm (CV)
- 1 x Mini Cacciavite piatto 6 x 38mm (CV)
- 1 x Cacciavite porta bit 1/4"
- 1 x Cacciavite porta bit a T 1/4"
- 1 x Scatola da 22 puntas 25mm Piatte, PH, PZ, Hex, Torx
- 1 x Cutter da 18mm
- 10 x Lame de 18mm
- 1 x Set di 9 chiavi a bussola 1/4"5-13mm
- 1 x Set di 8 chiavi esagonali 1,5-6mm
- 1 x Martello 300gr
- 1 x Flessometro da 3M x 16mm
- 8 x Altri strumenti (livella, sega a mano, forbice, spazzola, etc.)

Art.	EAN	📦
49370620		1

SET DI 35 PEZZI CON VALIGETTA



CONTENUTO:

- 1 x Pinze combinate 160mm
- 1 x Forbice 190mm
- 1 x Mini livella magnetica 228mm
- 1 x Cacciavite PH2 x 100mm (CV)
- 1 x Cacciavite piatto 5 x 100mm (CV)
- 2 x Cacciavite di precisione PH0
- 1 x Cacciavite di precisione piatto 2,0mm
- 1 x Cacciavite di precisione piatto 2,5mm
- 1 x Cacciavite porta bit magnetico 1/4"
- 1 x Scatola da 20 punte 25mm Piatte, PH, PZ, Hex, Torx
- 1 x Cutter da 18mm
- 2 x Lame da 18mm
- 1 x Martello 200gr
- 1 x Flessometro da 3M x 16mm

Art.	EAN	Immagine
49370610		1

SET DI UTENSILI MANUALI CON BORSA IN NYLON - 23PZ.

La borsa portautensili da 23 pezzi offre un'ampia gamma di utensili. Ideale come dotazione di base per l'officina nella robusta valigetta per l'impiego mobile.



CONTENUTO:

- 5 giraviti di precisione (SL 2/2,5/3 - PH0/00)
- 10 bits CR-V 25mm (PH1-2/PZ1-2/SL5,5/H4-5-6/T20-25)
- 1 flessometro 3m
- 1 cutter lama retraibile da 18mm
- 1 chiave a rullino (apertura max. 20mm)
- 1 manico per bits
- 1 tronchesine diagonali 160mm
- 1 pinze becchi lunghi 180mm
- 1 martello 200g manico in vetroresina
- 1 livella a bolla 200mm



Art.	EAN	Immagine
49370800		1

SET DI 63 PEZZI CON VALIGETTA

La valigetta portautensili da 63 pezzi offre un'ampia gamma di utensili. Ideale come dotazione di base per l'officina nella robusta valigetta per l'impiego mobile.



CONTENUTO:

- 1 Cesoia da taglio laterale 160 mm, CV
- 1 Pinza combinata 160 mm, CV
- 1 Pinza regolabile 240 mm, CV
- 1 Chiave a forca ad anello, 8-19 mm, 8 pz., CV
- 8 Chiave a bussola inserti 1/4", 8-12 mm, CV
- 8 Chiave a bussola inserti 3/8", 10-19 mm, CV
- 1 Cricchetto reversibile 3/8", CV
- 1 Cacciavite con impugnatura a T 1/4"
- 1 Cacciavite \oplus 2x100 mm, CV
- 1 Cacciavite \ominus 6x100 mm, CV
- 1 Cacciavite carburatore \oplus 2x40 mm, CV
- 1 Cacciavite carburatore \ominus 6x40 mm, CV
- 1 Martello da fabbro 300 g, GS
- 1 Taglierino
- 1 Set chiavi a brugola esagonali, 8 pz., 1,5-6 mm
- Set inserti da 22 pz. \ominus 3, 4, 5, 6 mm
- \oplus PH1, PH2, PH2, PH3
- \oplus PZ1, PZ2, PZ2, PZ3
- \bullet 3, 4, 5, 6 mm
- \bullet T15, T20, T25, T25, T27
- 1x \square \square \square \square 1/4"

Art.	EAN	Imb.
49375500		1

VALIGETTA PORTA UTENSILI - 199PZ.

La valigetta portautensili da 199 pezzi offre un'ampia gamma di utensili. Ideale come dotazione di base per l'officina nella robusta valigetta per l'impiego mobile.

CONTENUTO:

- 1 Cesoia da taglio laterale 160 mm, CV
- 1 Pinza combinata 180 mm, CV
- 1 Pinza regolabile 240 mm, CV
- 1 Chiave a forca ad anello 8-19 mm, 8 pz., CV
- 1 Cacciavite \oplus PH1 x 75 mm, CV
- 1 Cacciavite \oplus PH2 x 100 mm, CV
- 1 Cacciavite \ominus 5 x 75 mm, CV
- 1 Cacciavite \ominus 6 x 100 mm, CV
- 1 Cacciavite a punta \bullet 1/4"
- 2 Cacciavite carburatore \ominus 6 mm, \oplus PH2
- 1 Rivelatore di tensione, 200-250V, GS
- 1 Taglierino 18mm
- 5 Lame a spezzare, 18mm
- 1 Set chiavi a brugola esagonali, 8 pz., 1,5-6 mm, CV
- 1 Set Succhiello
 - 3x \square HM, TCT 5, 6, 8 mm
 - 3x \square HSS 5, 6, 8 mm
 - 3x \square CV 5, 6, 8 mm
- 3 Chiave a bussola inserti 3/8", 11-13 mm, CV
- 15 Chiave a bussola inserti 1/4", 4-13 mm, CV
- 1 Adattatore 1/4" - 3/8"
- 1 Portachiavi a bussola 1/4"
- 2 Prolunga 2" + 4"
- 1 Cricchetto reversibile 1/4", CV
- 1 Impugnatura scorrevole a T
- 1 Snodo cardanico
- 1 Martello da fabbro 300 g, GS
- Set inserti da 22 pz. \ominus 3, 4, 5, 5, 5, 6, 7 mm
- \oplus PH0, PH1, 3x PH2, PH3
- \oplus PZ1, 3x PZ2, PZ3
- \bullet 2,5, 3, 4, 5, 6 mm
- \bullet T10, T15, T20, 3x T25, T27, T30, T40
- 1x \square \square \square \square 1/4"
- 22 pz. Set di bit meccanici di precisione 28mm Bit, CRV
 - \ominus 1, 1,5, 2, 2,5, 3
 - \oplus PH00, PH0, PH1, PH2
 - \bullet T4, T5, T6, T8, T10, T15
 - U-2,6, Y-2,0, x-0,8, Δ -2,0, Pin
 - 1x
 - Estensione, 150 mm
- 10 Viti PZ
- 10 Viti PZ
- 10 Viti PZ
- 10 tasselli di nylon 8 mm in giallo
- 10 tasselli di nylon 6 mm in rosso
- 10 tasselli di nylon 5 mm in blu
- 6 Morsetti a molla, 2"
- 1 Nastro metrico 3 m x 16 mm
- 1 Sega per metallo + 3 Lame di sega



Art.	EAN	Imb.
49375561		1

GIRAVITI

SET DI CACCIAVITI PER ELETTRICISTA VDE ISOLATI 1000V + CERCAFASE - 7PZ.



PROFESSIONAL

- Acciaio Cromo Vanadio
- Manico Bicomponente

Omologati VDE



Art.	Composizione	N°pezzi	EAN	
49665307	PH1, PH2, Slot 2,5, 4, 5,5, 6,5	7		2

SET DI CACCIAVITI PER ELETTRICISTA VDE ISOLATI 1000V - 6PZ.



PROFESSIONAL

- Acciaio Cromo Vanadio
- Manico Bicomponente

Omologati VDE



Art.	Composizione	N°pezzi	EAN	
49140870	2,4 - 3,2 - 4,0 - 4,5mm	6		1

SET DI CACCIAVITI IN ACCIAIO CV - 4PZ.



CLASSIC

- Manico bicomponente
- Punta magnetica



Art.	Composizione	N°pezzi	EAN	
49141190	Slot 5,5 / 6,5mm, PH1, PH2	4		1

SET DI CACCIAVITI IN ACCIAIO CV - 8PZ.



CLASSIC

- CV cromato opaco
- Manico bicomponente
- Punta magnetica



Art.	Composizione	N°pezzi	EAN	
49141195	Slot 3,5 / 5,5 / 6,5 PH 0 / 1 / 2	8		1

SET DI CACCIAVITI IN ACCIAIO CV - 5PZ.



EXPERT

- CV cromato opaco
- Manico tricomponente
- Punta magnetica



Art.	Composizione	N°pezzi	EAN	
49665205	Slot 3,5 / 5,5 / 6,5 PH 1 / 2	5		2

SET DI 7 CACCIAVITI IN CV CON CERCAFASE



CLASSIC

- CV cromato opaco
- Manico bicomponente
- Punta magnetica



Art.	Composizione	N°pezzi	EAN	
49665207	PH1, PH2, PZ1, PZ2, Slot 5,5-6-5	6		2

SET DI BITS CON CACCIAVITE - 12PZ.

CLASSIC

- 3 Punta PH
- 3 Punta HEX
- 2 Punta SLOT
- 2 Punta PZ



Art.	Composizione	N°pezzi	EAN	
49151020	PH, PZ, SLOT, HEX	12	4009311510204	1

SET DI BITS CON CACCIAVITE - 12PZ.

CLASSIC

- 3 Punta PH
- 3 Punta PZ
- 4 Punta TORX



Art.	Composizione	N°pezzi	EAN	
49151010	PH, PZ, TORX	12	4009311510105	1

SET DI CACCIAVITI DI PRECISIONE - 6 PZ.

CLASSIC

- Cacciaviti Slot e PH
- Impugnatura fine ed ergonomica



Art.	Composizione	N°pezzi	EAN	
49145190	Slot 0,9-1,2-2,0 PH0, PH1, PH3	6	4009311451905	10

SET DI CACCIAVITI DI PRECISIONE PIATTI - 6PZ.

CLASSIC

- Cacciaviti Slot
- Impugnatura fine ed ergonomica



Art.	Composizione	N°pezzi	EAN	
49145090	0,9 - 1,2 - 2,0 - 2,4 - 3,0 - 3,5mm	6	4009311450905	10

SET DI CACCIAVITE CON LUCE LED E 10 BITS ASSORTITI

CLASSIC

- Acciaio Cromo-Vanadio
- Completo con PH, PZ, TX



Art.	Tipo punte	Lung. bits	EAN	
49116890	PH-PZ-TORX	25mm		12

CERCAFASE OMOLOGATO VDE

PROFESSIONAL

- Omologato VDE
- Protezione della mano



Art.	Tensione	EAN	
49142900	125 - 250 V		12

CHIAVI DI SERRAGGIO

SET DI CHIAVI A BUSSOLA CON CHIAVE A CRICCHETTO DA 1/4" - 29PZ.

- Con prolunga da 100mm
- PH-PZ-TORX-HEX-Piatti



Art.	Composizione	N°pezzi	EAN	
49372420	4-14mm	29		4

CHIAVE A CRICCHETTO

EXPERT



Art.	Attacco	EAN	
49372160	1/4"		1
49372360	1/2"		1

SET DI CHIAVI A BUSSOLA CON CRICCHETTO 1/4" - 13PZ.

CLASSIC

- Acciaio Cromo-Vanadio
- Chiave a cricchetto con manico zigrinato anti-scivolo



Art.	Composizione	N°pezzi	EAN	
49371990	4-13mm	13		8

SET DI CHIAVI A BUSSOLA E BITS CON CHIAVE A T 1/4" - 21PZ.

EXPERT



Art.	Composizione	N° pezzi	EAN	
49119390	1/4"	21		6

CHIAVE COMBINATA 19MM

CLASSIC

- Acciaio CV opaco
- Finitura satinata



Art.	Dimensioni	EAN	
49460419	19mm		2

SET DI CHIAVI COMBinate - 4PZ.

CLASSIC

- Acciaio CV opaco
- Finitura satinata



Art.	Dimensioni	N° pezzi	EAN	
49460490	10-13-15-17mm	4		1

SET DI CHIAVI COMBinate - 8PZ.

CLASSIC

- Acciaio CV
- Finitura satinata



Art.	Dimensioni	N° pezzi	EAN	
49460390	8-19mm	8		4

SET DI CHIAVI A FORCHETTA DOPPIE - 8PZ.



CLASSIC

- Acciaio CV
- Finitura satinata



Art.	Dimensioni	N° pezzi	EAN	
49470390	6-22mm	8		4

SET DI CHIAVI POLIGONALI - 8PZ.



EXPERT

- Acciaio CV opaco
- Finitura satinata



Art.	Misure	EAN	
49440390	6-22mm		1

SET DI CHIAVI A PIPA - 5PZ.



EXPERT

- Acciaio CV opaco
- Finitura satinata



Art.	Misure	EAN	
49470150	8-13mm		5

SET DI CHIAVI A TUBO CON LEVA ESTENSIBILE - 10PZ.



CLASSIC



Art.	Misure	EAN	
49110590	6-22mm		1

SET DI CHIAVI ESAGONALI LUNGHE CV - 9PZ.



EXPERT

- Acciaio CV
- Alloggio in plastica
- Norma DIN 911
- Testa a sfera



Per lavori ad angolo in punti di difficile accesso

Art.	Dimensioni	N°pezzi	EAN	
49147600	1, 5/ 2 / 2,5 / 3 / 4 / 5 / 6 / 8 / 10mm	9		1

CHIAVE UNIVERSALE PER LAVABO

PROFESSIONAL

- Testa orientabile per zone difficilmente accessibili



Art.	Lunghezza	Grandezza SW	EAN	
49981000	250mm	10-28mm		6

PINZE E TRONCHESI

PINZA COMBINATA IN DISPLAY DA 16PZ.

CLASSIC

- Qualità-prezzo
- Manico bicomponente
- Per taglio fili, serraggio e piegatura



Art.	Lunghezza	Materiale	N°pezzi	EAN	
49386390	180mm	Acciaio al carbonio	16		16

PINZA A BECCHI LUNGI IN DISPLAY DA 16PZ.

CLASSIC

- Qualità-prezzo
- Manico bicomponente
- Per serraggio e piegatura





Art.	Lunghezza	Materiale	N°pezzi	EAN	
49382390	200mm	Acciaio al carbonio	16		16

TRONCHESINO IN DISPLAY DA 16PZ.

CLASSIC

- Qualità-prezzo
- Manico bicomponente
- Per taglio di fili metallici e chiodi temprati





Art.	Lunghezza	Materiale	N°pezzi	EAN	
49383190	160mm	Acciaio al carbonio	16		16

PINZA A PAPPAGALLO IN DISPLAY DA 12PZ.

CLASSIC

- Acciaio CV
- Manico bicomponente
- Presa dentata





Art.	Lunghezza	Materiale	N°pezzi	EAN	
49387790	240mm	Acciaio al carbonio	12		12

SET DI PINZE - 3PZ.

CLASSIC

- Manico bi-componente
- Set completo
- Qualità-prezzo



Art.	Lunghezza	Materiale	N°pezzi	EAN	
49381090	160mm	Acciaio al carbonio	3		1

PINZA COMBINATA CV

EXPERT

- Acciaio CV
- Manico bicomponente
- Per taglio fili, serraggio e piegatura



CV



Art.	Lunghezza	Materiale	EAN	
49386410	200mm	CV		6

CHIAVE INGLESE CV

PROFESSIONAL

- Acciaio CV
- Finitura satinata
- Morsetto regolabile senza gradini
- Manico bicomponente



CV



Art.	Lunghezza	Apertura "	Apertura mm	EAN	
49167800	200mm	1"	24mm		2
49167900	250mm	1+1/8"	28mm		2
49168000	300mm	1+1/4"	32mm		2

PINZA MULTIFUNZIONE PER CAPICORDA E SPELAFILI

EXPERT



Art.	Lunghezza totale	EAN	
49403100	200mm		1

PINZA A SCATTO 225 MM

CLASSIC

- Leva a sgancio rapido



Art.	Lunghezza	Apertura	EAN	
49408000	225mm	0-40mm		6

PINZA PER ANELLI INTERNI ED ESTERNI



CV

CLASSIC

- Per anelli interni ed esterni
- Pratica e resistente
- Ottimo rapporto qualità-prezzo



Art.	Lunghezza	Diametro min.	Diametro max.	EAN	📦
49403900	150mm	10mm	15mm		6

SET DI PINZE PER ELETTRONICA - 4PZ.



CV

CLASSIC

- Acciaio cromo-vanadio
- Assortimento completo
- Ottimo rapporto qualità-prezzo



Art.	Lunghezza	EAN	📦
49369890	120mm		5



UTENSILI PER MASCHIATURA E FILETTATURA

MASCHIO PER FILETTATURA MANUALE IN ACCIAIO HSS

PROFESSIONAL

- DIN 352



Art.	Ø	ISO	EAN	📦
49443003	3mm	M3		3
49443004	4mm	M4		3
49443005	5mm	M5		3
49443006	6mm	M6		3
49443008	8mm	M8		3
49443010	10mm	M10		3
49443012	12mm	M12		3



GIRAMASCHI REGOLABILE IN ACCIAIO HSS

PROFESSIONAL



Art.	Ø	EAN	📦
49443920	1-12mm		5

FILERA TONDA PER MASCHIATURA MANUALE IN ACCIAIO HSS

PROFESSIONAL

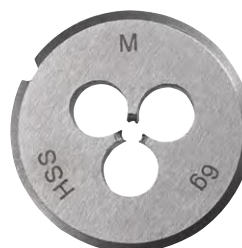

Art.	Ø	ISO	EAN	📦
49444003	3mm	M3		3
49444004	4mm	M4		3
49444005	5mm	M5		3
49444006	6mm	M6		3
49444008	8mm	M8		3
49444010	10mm	M10		3
49444012	12mm	M12		3



PORTAFILIERA REGOLABILE M 1-12 IN ACCIAIO HSS

PROFESSIONAL



Art.	Ø	EAN	📦
49444930	1-12mm		5

SET PER MASCHIATURA E MATRICI - 16 PZ.

CLASSIC

- 7 Maschi M3-M12
- 7 Filiere M3-M12
- 1 giramaschio DIN 1814
- 1 portafiliera DIN 223



Art.	N° pezzi	Ø	EAN	📦
49445100	16	M3-M4-M5-M6-M8-M10-M12		1



FORBICI E CESOIE

CESOIE PER LAMIERA

PROFESSIONAL



Art.	Tipo di taglio	Lunghezza totale		
49926300	Dritto	250mm		6
49926200	Dx	250mm		6
49926100	Sx	250mm		6

FORBICI TAGLIACAVI

EXPERT

- Forma ergonomica
- Manico bicomponente
- Per destri e mancini



Art.	Lunghezza	EAN	
49025600	145mm		8

FORBICE MULTIFUNZIONE

EXPERT

- Apribottiglie integrato



Art.	Lunghezza	EAN	
49020721	205mm		8

SET DI FORBICI IN ACCIAIO INOX - 3PZ.

CLASSIC

- Set completo
- Qualità-prezzo
- Per destri e mancini



Per tessuti, sartoria e carta

Art.	Lunghezza	N° pezzi	EAN	
49021595	140,210,250mm	3		6

RIVETTATRICI E OCCHIELLATRICI

RIVETTATRICE 250 MM

PROFESSIONAL

- Versione pesante
- Manico con protezione



Per rivetti in alluminio e rame
Per lamiere in metallo

Art.	Ø rivetti	EAN	📦
49407200	2,4 / 3,2 / 4,0 / 4,8mm		3

RIVETTI

PROFESSIONAL



Art.	Ø	Lunghezza	N° pezzi	EAN	📦
49407457	3,2mm	6,5mm	50		10
49407459	3,2mm	9,0mm	50		10
49407462	3,2mm	12,0mm	50		10
49407470	4,0mm	10,0mm	50		10
49407472	4,0mm	12,0mm	50		10
49407476	4,0mm	16,0mm	50		10
49407478	4,8mm	8,0mm	50		10
49407482	4,8mm	12,0mm	50		10
49407486	4,8mm	16,0mm	50		10



OCCHIELLATRICE IN FERRO

EXPERT

- Con 12 occhielli
- Manico con protezione



Per carta, cartone,
e lamine di plastica

Art.	Ø	Lunghezza	EAN	📦
49	10mm	150mm		6
49929716	16mm	175mm		6



OCCHIELLATRICE E FUSTELLATRICE

CLASSIC

- Occhielli inclusi
- Punzonatura e piegatura

Per cuoio, tessuti
lamine in plastica



Art.	Ø	EAN	📦
49929690	10-16mm		6

OCCHIELLI OTTONATI

CLASSIC

- Per perforatrice
- Ottimo rapporto qualità-prezzo

Per cuoio, tessuti e plastica



Art.	Ø	N° pezzi	EAN	📦
49929810	10mm	20		6
49929816	16mm	20		6

SPATOLE

SPATOLA SINGOLA IN METALLO

PROFESSIONAL



Art.	Larghezza spatola	EAN	📦
49029400	40mm		12
49029500	50mm		12
49029600	60mm		12

SET DI SPATOLE IN METALLO O PLASTICA

EXPERT

- Flessibili e precise



Art.	Materiale	Larghezza	N° pezzi	EAN	📦
49029990	Metallo	50, 80, 100, 120mm	4		10
49032290	Plastica	50, 80, 100, 120mm	4		5

VENTOSA PER SOLLEVAMENTO SINGOLA O DOPPIA

CLASSIC



Art.	Tipo	Peso max.	EAN	
49179890	Singola	30kg		6
49179990	Doppia	60kg		1

PISTOLA PER POLIURETANO ESPANSO

CLASSIC

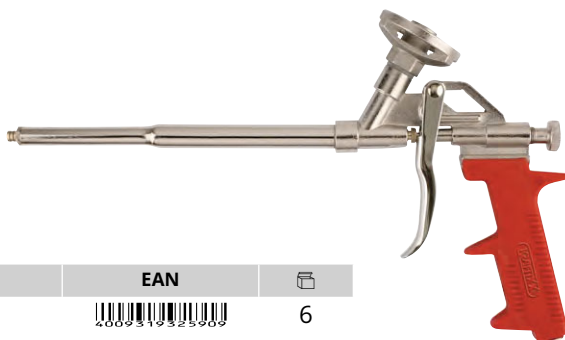

Art.	-	EAN	
49932590	-		6

COLTELLI E CUTTER

COLTELLO DA SALVATAGGIO FIRE DEPARTMENT

PROFESSIONAL

- Con funzione frangi-vetro e taglio cintura di sicurezza
- Con clip per cintura



Art.	Lunghezza lama	EAN	
49014710	90 mm		6

PINZA MULTIFUNZIONE IN DISPLAY DA 10PZ.

CLASSIC

- Manico in alluminio
- Pinze e tronchesi
- Cacciavite PH
- Lima, apriscatole, apribottiglie, seghetto



Art.	Lunghezza	N° funzioni	N°pezzi	EAN	
49016225	102mm	10	10		10

COLTELLINO SVIZZERO 11 FUNZIONI

CLASSIC

- Carcassa in alluminio
- Cacciavite PH, apriscatole
- Lima e apribottiglie
- Lama in acciaio inox
- Seghetto, forbici, punzone



Art.	Larghezza	N° funzioni	EAN	📦
49016120	90mm	11		10

CUTTER CON LAMA RETRATTILE IN BLISTER

EXPERT

- Acciaio inox robusto
- Blocco automatico
- Carcassa in ghisa pressofusa
- Impugnatura in gomma



Art.	Larghezza lama	N°pezzi	EAN	📦
49015109	9mm	110 x 25mm		4

CUTTER CON LAMA RETRATTILE IN DISPLAY DA 20PZ.

EXPERT

- Acciaio inox robusto
- Blocco automatico
- Carcassa in ghisa pressofusa
- Impugnatura in gomma



Art.	Larghezza lama	Dimensioni	N°pezzi	EAN	📦
49015121	18mm	110 x 25mm	20		20

CUTTER CON LAMA RETRATTILE CARCASSA IN PLASTICA

EXPERT

- Acciaio inox robusto
- Blocco automatico



Art.	Larghezza lama	Dimensioni	EAN	📦
49026095	18mm	110 x 25mm		24

SET DI LAME DI RICAMBIO PER CUTTER

QUALITY

- Contenitore in plastica
- Molto affilate



Art.	Larghezza lama	N°pezzi	EAN	📦
49022990	9mm	10		24
49023395	18mm	10		24



STRUMENTI DI MISURAZIONE

FLESSOMETRO IN ACCIAIO

PROFESSIONAL

- Retrazione automatica



Certificato CE
Corpo principale
in plastica ABS



Art.	Lunghezza	Larghezza nastro	EAN	📦
49060102	2 m	16mm	4009310601022	5
49060103	3 m	16mm	4009310601033	5
49060105	5 m	19mm	4009310601057	5
49060810	10 m	25mm	4009310608100	5

FLESSOMETRO IN ACCIAIO

PROFESSIONAL

- Retrazione automatica



Certificato CE
Corpo principale
in plastica ABS

Art.	Lunghezza	Larghezza nastro	N°pezzi	EAN	📦
49060113	3 m	16mm	18		18
49060115	5 m	19mm	12		12

MINI LIVELLA 225 MM

PROFESSIONAL

- Per uso verticale e orizzontale
- Resistente agli impatti e ai raggi UV



Corpo di protezione in plastica
Foro per agganciare

Art.	Lunghezza	Altezza	EAN	📦
49065280	225mm	30mm		5

RILEVATORE DI CORRENTE SAFETY FIXX

PROFESSIONAL

- Alta sensibilità
- Calibratura automatica in base alla superficie



Rileva la presenza di cavi
elettrici metallo e legno

Art.	-	EAN	📦
49011620	-		2

ACCESSORI DA LAVORO

PORTA MARTELLO A STAFFA

PROFESSIONAL

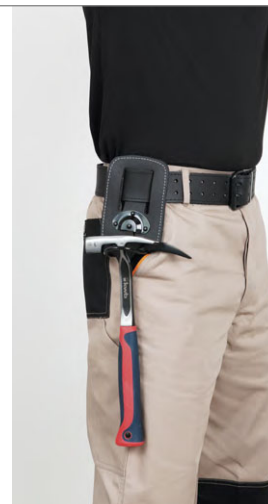

Art.	Dimensioni	EAN	
49906110	155 x 100mm		5

CUSTODIA PER CELLULARE

PROFESSIONAL



Art.	Dimensioni	EAN	
49907210	140 x 80mm		5

FODERA PORTA TRAPANO AVVITATORE

PROFESSIONAL





Art.	Dimensioni	EAN	
49907510	210x150x100mm		5

CINTURA IN NYLON

PROFESSIONAL



Art.	Dimensioni	EAN	
49908815	135 x 5,1 cm		5

FONDINA DA ELETTRICISTA

PROFESSIONAL





Art.	Dimensioni	EAN	
49907610	270x150mm		5

BORSA PORTA UTENSILI A CINTURA 8 SCOMPARTI

PROFESSIONAL

- Per tutti i tipi di arnesi
- Organizzazione migliorata



Art.	Dimensioni	EAN	
49907710	75-135 x 5cm		5

MATERIALI DI COMPOSIZIONE

CV	Cromo-vanadio
HSS DIN 338 Typ N	Acciaio rapido tipo N
HSS	Acciaio rapido
HSS M2	Acciaio rapido con lega di tipo M2
HSS CO	Acciaio rapido al cobalto
HSS BIM	Acciaio rapido con lega Bimetallica
BIM	Lega bimetallica (miscela di HSS e HCS)
HCS	Acciaio al carbonio
HM TCT	Carburo di tungsteno
HM	Metallo duro
	Diamante sintetico
T TITAN	Rivestimento in titanio

PARTICOLARITÀ

	Angolo di taglio 118°
	Angolo di taglio 135°
	Punta in metallo duro
	Punta a 4 taglienti in metallo duro
	Qualità TQ-60
	Denti alternati
	Attacco esagonale 1/4" E.6.3
	Attacco esagonale
	Utensile con attacco esagonale
	Attacco SDS Plus
	Attacco SDS MAX
	Foratura senza percussione

	Velcro
	Uso con smerigliatrice
	Uso con trapano
	Zigrinatura
	Magnetico
	Sistema anti-torsione
	Avvio graduale
	Angolo 90°



MATERIALI DI APPLICAZIONE

	Calcestruzzo Armato
	Calcestruzzo
	Vetrocemento
	Arenaria Calcareo
	Pietra naturale
	Granito
	Mattoni e Muratura
	Blocchi Forati
	Blocchi di Calcestruzzo
	Clacestruzzo disattivato
	Clinker da pavimento
	Marmo
	Piastrelle
	Gres Porcellanato
	Tegole
	Piastrelle e Colla per piastrelle
	Ardesia
	Intonaco
	Massetto
	Materiale da costruzione leggero
	Moquette
	Silicone acrilico
	Plexiglas
	Gomma
	Vetroresina

	Plastica
	PVC
	Vetro
	Colore
	Legno tenero
	Legno duro
	Casseforme
	Laminato
	MDF - Melamina
	Truciolato
	Truciolato rivestito
	Compensato
	Listelli di legno
	Legno da costruzione
	Parquet
	Paniforte
	Cerniere
	Rimozione colore dal legno
	Potatura
	Legna per camino
	Legno per profili
	Tavole da terrazza
	Bronzo
	Ferro
	Acciaio

	Acciaio Inox
	Profili metallici
	Alluminio
	Lamiere
	Ghisa
	Metalli non-ferrosi (rame, zinco, nichel)
	Rimozione ruggine
	Rimozione colore da metallo

TAGLIO

	Taglio grossolano
	Taglio medio
	Taglio fine
	Taglio curvo
	Taglio inverso
	Dentatura varia
	Spaziatura dei denti
	Dentatura giapponese

QUALITÀ

	Fabbricazione Europea
	OSA
	Velocità di taglio ottimizzata
	Certificato SicherSafe
	Risparmio energetico



Einhell

ECCELLENZA NELLA BATTERIA.



DUE PARTNER. UNA MISSIONE. IL MASSIMO DELLE PERFORMANCE.

EINHELL È ORGOGLIOSA DI ESSERE PARTNER
DI MERCEDES-AMG PETRONAS F1 TEAM.



OFFICIAL
TOOL EXPERT



AMG
PETRONAS
FORMULA 1 TEAM



ACCESSORI PER ELETTROUTENSILI & UTENSILI MANUALI 2026

Hai domande sui nostri prodotti?
Vuoi ordinare una parte di ricambio?
Il tuo prodotto non funziona più come il primo giorno?
Einhell è a tua disposizione e ti forniamo il nostro aiuto
in modo semplice, diretto e rapido.



Einhell Italia srl
Via delle Acacie snc
22070, Binago (CO)



+ 39 (0) 031 99 20 80



www.einhell.it



service-italia@einhell.com

Einhell Italia srl

Via delle Acacie snc | 22070, Binago (CO)
Tel. 031 992080 | Fax 031 992084
info@einhell.it | www.einhell.it

Fatto salvo diverse comunicazioni e/o revoche esaurimento scorte ed errori e/o omissioni:
le foto hanno valore puramente indicativo.

Prezzi consigliati al pubblico. I prezzi presenti sul catalogo sono comprensivi di IVA.

In qualunque momento e senza alcun preavviso, Einhell Italia S.r.l. si riserva il diritto di modificare i prezzi, anche nel caso in cui venga pubblicato un prezzo errato, per qualsiasi ragione (di stampa, umano...). Inoltre, durante il periodo di validità di questo catalogo (fino al 31/12/2026) Einhell Italia S.r.l. potrà scegliere, in totale autonomia, di portare avanti campagne promozionali e/o di sconto sui prodotti inclusi nel catalogo.

Se il presente volantino fosse esposto al pubblico, deve essere regolarizzato agli effetti dell'imposta comunale sulla pubblicità a cura di chi lo espone. Eventuale comunicazione al Comune di competenza come da D.LGS. 15/11/1993 n. 507 e successive modifi che, a cura del dettagliante.

einhell.it

